

siteco

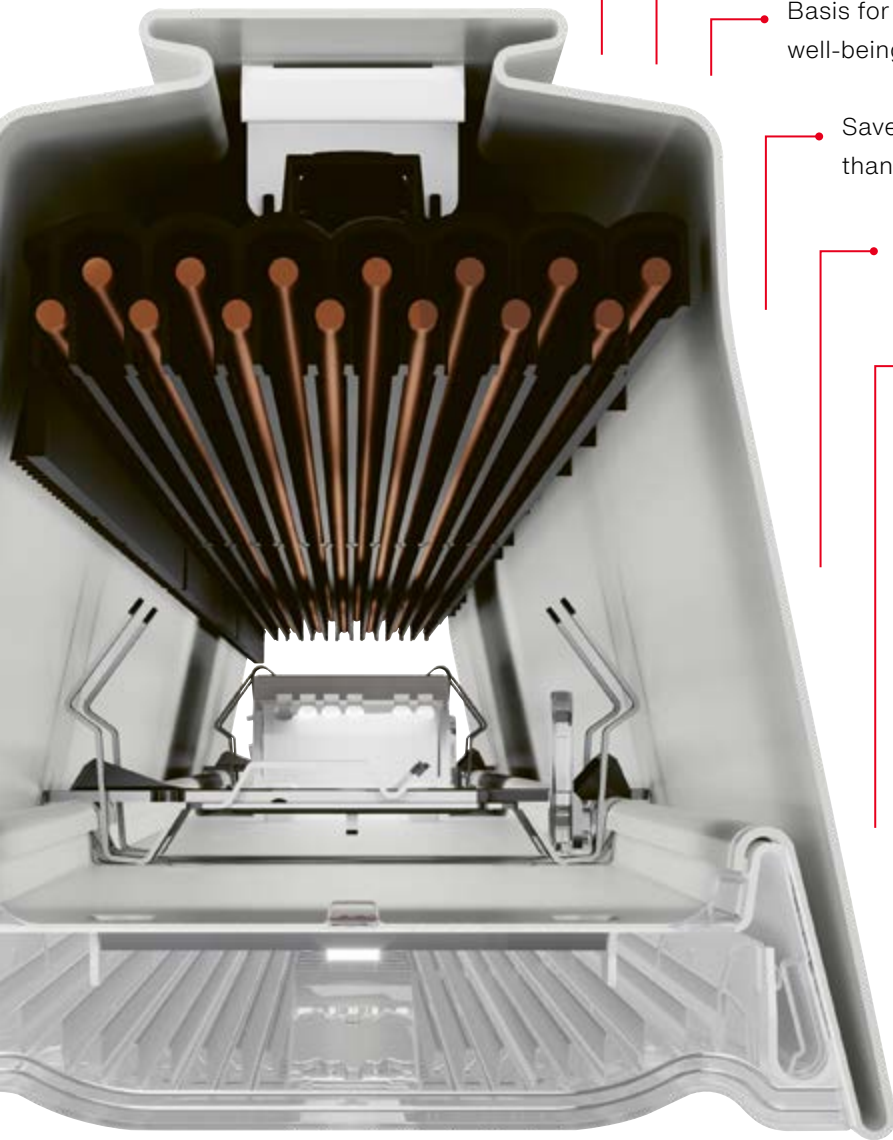

14 cores for networking without additional wiring effort.

Click system for easy integration of sensors, WiFi, audio, video, emergency lighting and more.

Basis for HCL^{live} to increase well-being and motivation.

Save up to 80 % energy and CO₂ thanks to maximum efficiency.

Multilumen function and CLOi for unmatched adaptability.

Best light: Wide range of luminaire inserts and optimum glare control up to UGR < 19

Licross[®] Trunking

The backbone of your infrastructure.

14 cores and full flexibility are a must for tomorrow.
45 years of experience – trunking *Made in Germany*.

Setting the course for tomorrow today.

State-of-the-art lighting technology means maximum efficiency. For us, that is not enough. We offer a system that becomes the backbone of your building infrastructure and goes far beyond lighting. A solution with maximum flexibility in application and already equipped today for the requirements of the future.

Licross® - the backbone of your digital infrastructure.

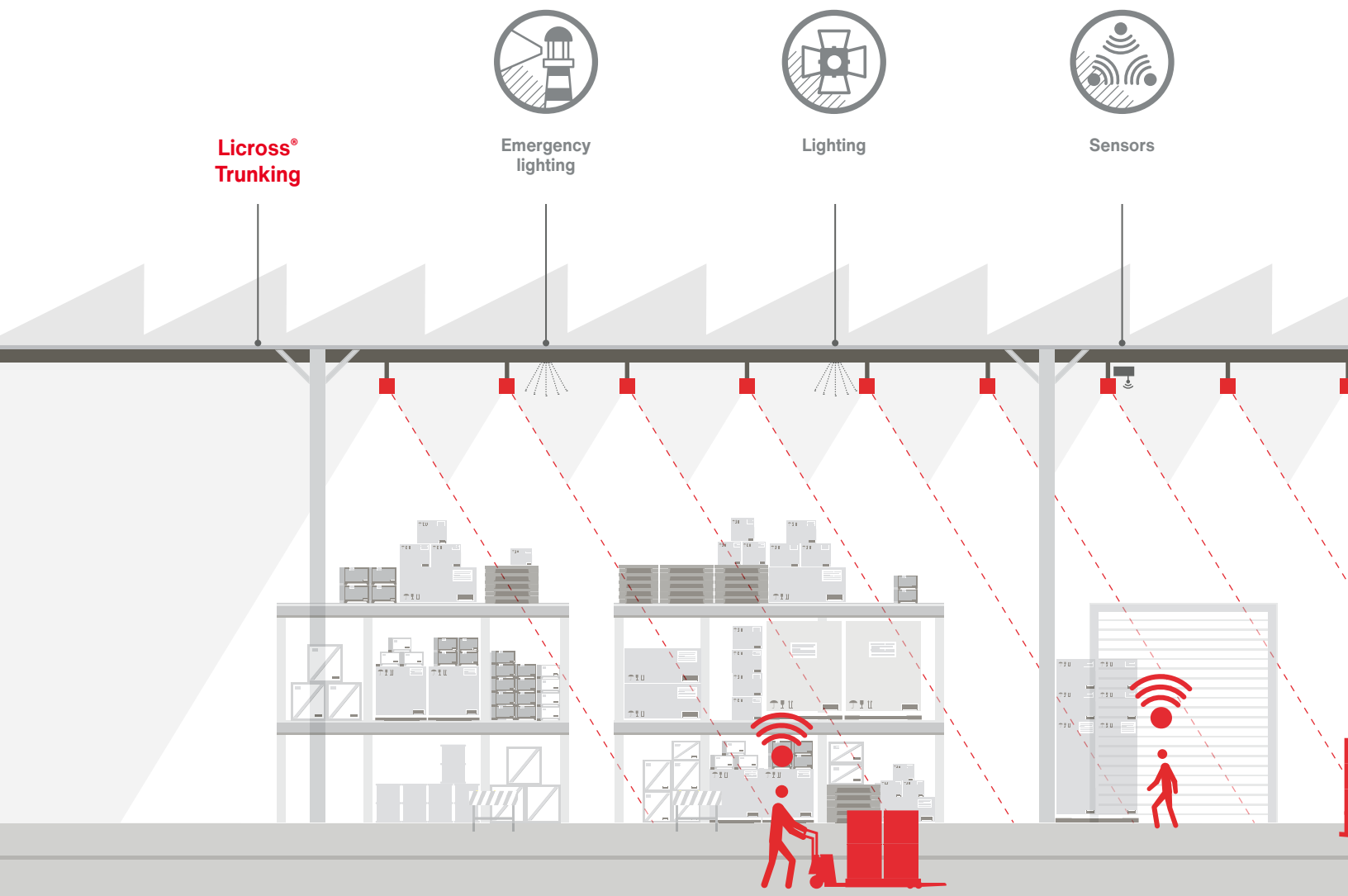

14 cores for a new level of networking.

Free cores in the Licross® trunking system enable ultra-fast data transmission to the device of your choice, over distances that can be three times as long as a normal network connection. Thanks to a well-thought-out family concept, a wide range of IT devices such as WiFi, cameras or audio systems can easily be connected to the trunking system via our standardised ethernet sockets.

This allows you to bundle smart technology at the luminaire and thus optimise the space and appearance of your building's ceilings. At the same time, you minimize the complexity on the construction site and reduce the fire load of your building.



Connectivity
(UWB, WiFi, NFC, etc.)



Video
surveillance



Audio
systems



UVC air
purifier

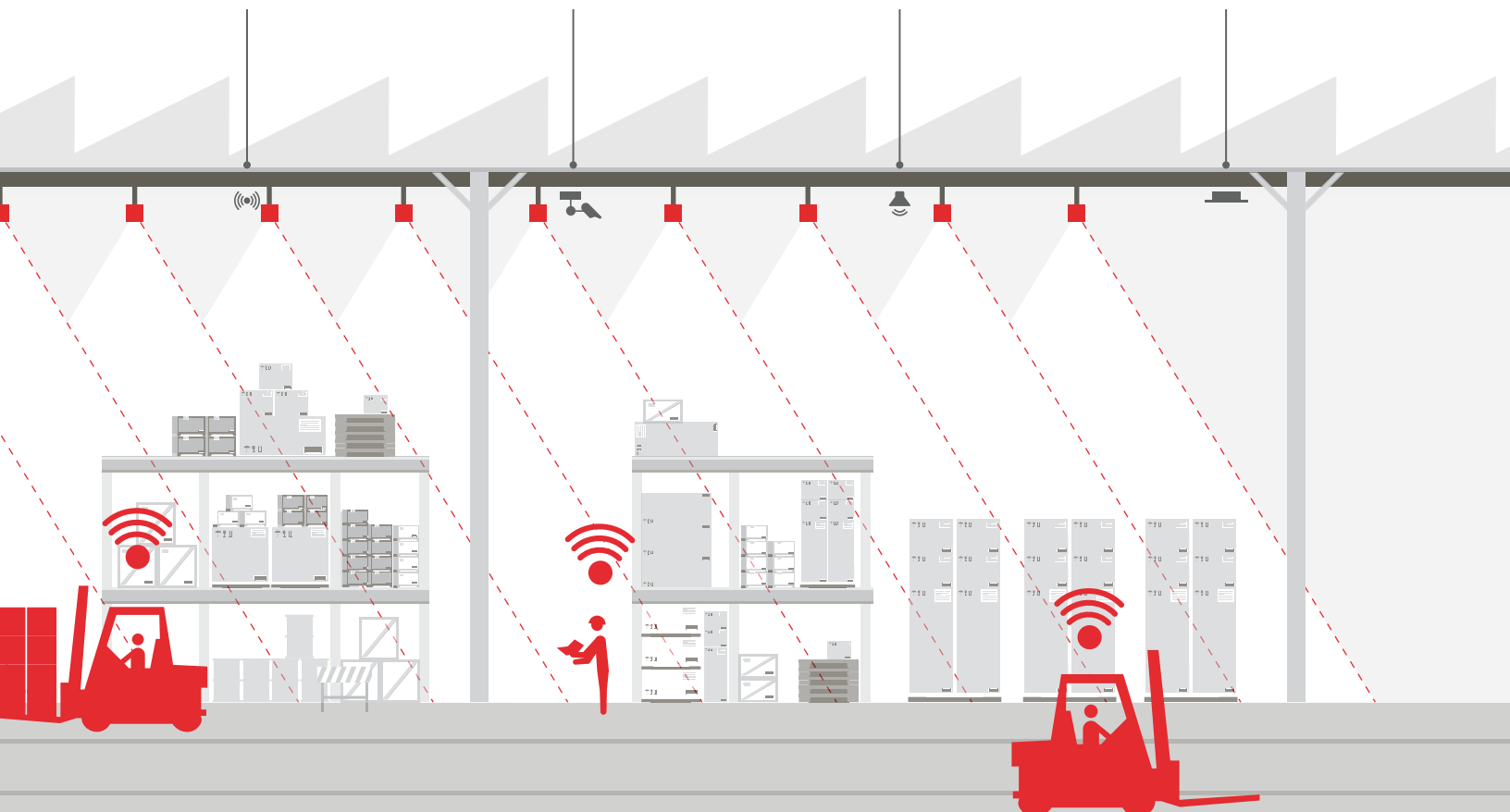



SITECO Connect Audio

What do shops, large offices, hotels and industrial halls have in common? They are all spacious and need loudspeakers for announcements, music or voice alarms. With SITECO Connect Audio, Licross® becomes a medium for communication. This saves redundant electrical installations, because two free conductors inside the trunking system are quickly used for audio transmission.

Designation	Details	Colour	Order number
Licross® loudspeaker adapter	Licross® insert for mounting and connection of loudspeaker 59UA ... LT, wire pair selectable (D1 +/- or D2 +/-)	white	56TL1LT
Loudspeaker for adapter 56TL1LT	Loudspeaker for mounting on loudspeaker adapter 56TL1LT, 2-way technology, 10W nominal power, certified for voice alarm systems according to EN 54-24	white	59UA1LT
		jet-black	59UA3LT
		metallic grey	59UA6LT
Amplifier for announcements and music	Power amplifier for the transmission of speech and music, 120 W nominal power, for the operation of max. 10 loudspeakers 59UA ... LT	black	59UA3VT
Table microphone for announcements	Table microphone for announcements, up to 2 units can be connected to mixing amplifier 59UA3VT, talk button, locking lever, 2.5 m connection cable, jack plug 6.3 mm	black	59UA3PT

① Speaker adapter

- Interface for the integration of a loudspeaker in the trunking system - easy to install thanks to bracket with mounting lock and plug-in connection for automatic contacting
- Can be positioned anywhere in the trunking rail for maximum flexibility
- Can be combined with a range of loudspeaker modules for freedom in planning

② Loudspeaker

- 2-way loudspeaker for crystal clear announcements and excellent music experience
- Certified according to EN 54-24 and thus suitable for use in voice alarm systems – maximum security and planning freedom for your building
- Easy installation thanks to plug-in connection and design flexibility via three colour options

③ Mixing amplifier

- Desktop mixing amplifier with 120 W for a powerful audio signal – suitable for the connection of up to 10 loudspeakers
- 2 universal audio inputs for parallel connection of microphone and music source for highest flexibility and ease of use
- Usable as a desktop unit and suitable for common mounting racks

④ Microphone

- Table microphone for announcements with first-class voice quality
- Easy operation with large intercom button and locking lever to prevent unintentional operation
- Including 2.5 meter cable for great freedom in positioning and mounting



SITECO Connect IP

With SITECO Connect IP, Licross® becomes a data highway. Free conductors are used to enable data transmission at up to 1 Gbit/s and up to a transmission length of over 300 m.

The link to the network is established via the Licross® LAN connector. Universal interfaces (PoE adapters) are then simply clicked into the trunking rail – just like luminaire inserts – and enable cameras, WiFi routers or other IP devices to be operated. Up to 12 ports / IP participants are possible at any location. Communication and bandwidth allocation are dynamic and automatic.

Licross® thus becomes the backbone of the building's digital infrastructure. It saves additional installations, can be easily expanded or retrofitted and ensures a tidy ceiling.



5 LAN connector

- Link to the network

6 PoE adapter

- For mechanical and electrical connection of IP devices such as cameras

Designation	Details	Colour	Order number
Licross® LAN connector	Network connection, 1 Gbit/s, RJ45 plug connection, max. 12 subscribers, max. 300 m Licross® rail length	white	56TL1NN00A
		jet-black	56TL3NN00A
		metallic grey	56TL6NN00A
Licross® POE adapter	Mounting and connection option for IP subscribers, RJ45 plug connection, max. 12 adapters in connection with a LAN port, active Power-over-Ethernet* supply	white	56TL1UN00A
		jet-black	56TL3UN00A
		metallic grey	56TL6UN00A

* Power-over-Ethernet according to IEEE 802.3af (12.95 W), wire pair selectable (D1 +/- or D2 +/-), dynamic bandwidth distribution between all nodes (dynamic switch), bandwidth reduction with increasing distance to the LAN connection.

Typical applications

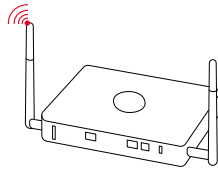

Internet access

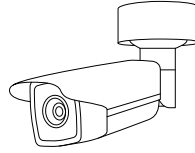

Video

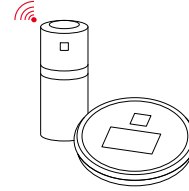

Tracking
(e.g., material flow monitoring)

The advantages at a glance

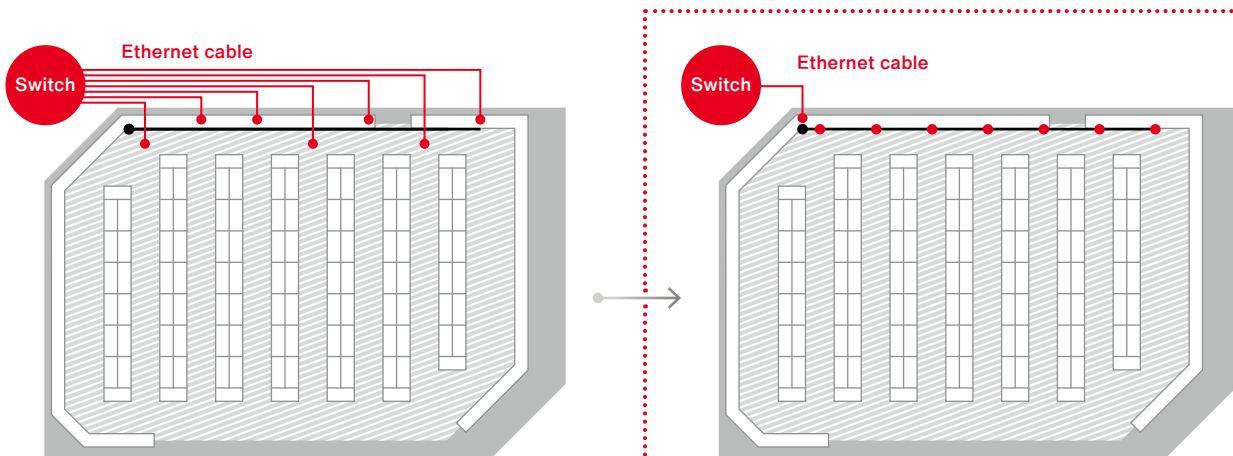

Up to now complex installation:

- ⊖ Large installation effort
- ⊖ Only a maximum of 100 m transmission length
- ⊖ Low flexibility
- ⊖ High material expenditure
- ⊖ Large dimensioning of the network components
- ⊖ Visually mostly unsatisfactory

Optimized structure:

- ⊕ Low installation effort
- ⊕ Transmission length > 300 m
- ⊕ High flexibility
- ⊕ Low material costs
- ⊕ Network components can be dimensioned smaller
- ⊕ Easy retrofitting of devices
- ⊕ Tidy ceiling



Insert available in the following colours:



Licross® Trunking Rail

- Trunking rails with up to 14 cores for a new level of networking
- Wide range of rail and insert configurations to meet your demands

Licross® Recessed

- A simple way to achieve illumination according to requirements thanks to many different light distributions
- Uniform design due to rail-flush integration
- Very high luminous flux of up to 26,000 lm

Licross® Protected

- High resistance and suitability for ambient temperatures of up to 50° C over complete service life
- Very robust system with protection ratings up to IP64 / IK06 and at the same time high luminous flux of up to 14,000 lm

Licross® Performance

- Special optic technology for very high visual comfort with up to UGR < 19 and suitability for VDU workstations
- Attractive interior design with up to 23 % indirect light component – ideal for SITECO HCL^{live}

Licross® Retail solutions

- Spot: Accent lighting and excellent colour rendering for attractive interior design or product presentation
- Washer: Asymmetrical wide light distribution provides deep, uniform illumination of walls, shelves or blackboards

Licross® Trunking Rail

Material	sheet steel, galvanised
Through-wiring	no wiring, 7 x 2.5 mm ² , 14 x 2.5 mm ²
Colour	metallic grey (RAL 9006), white, jet-black (RAL 9005)
Length	1,500, 3,000, 4,500 mm
Protection class / rating	Protection class I / up to IP64 (depending on inserts used)

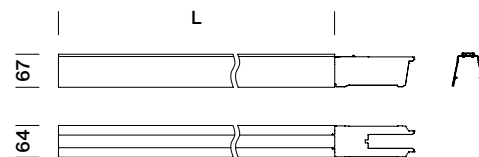

Licross® Recessed

Net luminous flux	up to 26,230 lm
Luminous efficacy	up to 181 lm / W
Light distribution	wide, medium, narrow, asymmetric, diffuse distribution
Control	ON / OFF, Multilumen with CLOi, DALI, DALI TW
Protection rating	IP40
Ambient temperature	-35 ... +50° C*
Rated service life	up to 100,000 hours
L-value	up to L100

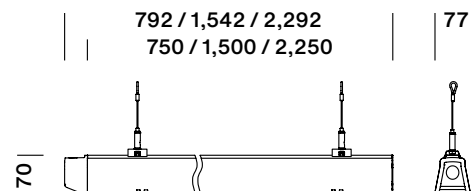

Licross® Protected

Net luminous flux	up to 14,700 lm
Luminous efficacy	up to 174 lm / W
Light distribution	wide, narrow, extremely narrow
Control	ON / OFF, Multilumen with CLOi, DALI, DALI TW
Protection rating	IP50, IP54, IP64
Ambient temperature	-35 ... +50° C*
Rated service life	up to 100,000 hours
L-value	up to L100

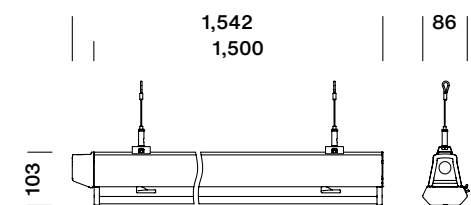

Licross® Performance

Net luminous flux	up to 14,250 lm
Luminous efficacy	up to 171 lm / W
Light distribution	direct / indirect distribution
Control	ON / OFF, Multilumen with CLOi, DALI, DALI TW
Protection rating	IP50
Ambient temperature	-35 ... +50° C*
Rated service life	up to 100,000 hours
L-value	up to L100

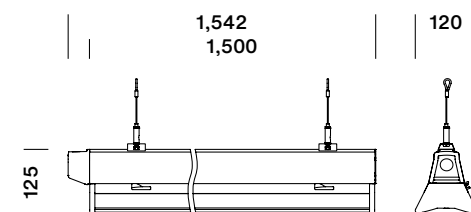

Licross® Retail solutions

	Licross® Spot 31	Licross® Shelf- / Wallwasher
Net luminous flux	up to 4,800 lm	up to 5,740 lm
Luminous efficacy	up to 120 lm / W	up to 119 lm / W
Light distribution	18°, 24°, 36°, 55° lens optics	90° asymmetrical distribution to the right (Shelfwasher), asymmetrical distribution with an inclination of 0° / -5° / +5° (Shelfwasher / Wallwasher)
Control	DALI, ON / OFF	DALI, ON / OFF
Protection rating	IP20	IP20
Ambient temperature	-20 ... +40° C	-25 ... +40° C
Rated service life	up to 50,000 hours	up to 50,000 hours
L-value	up to L80	up to L80

* With DIP position 8 (BDF) up to 50° C.

Licross® Trunking Rail



Colour	Number of cores	Protection rating	Order number		
white	14-core	1,500	IP20 / IP40 / IP50 / IP64	51TR1CE	
		3,000	IP20 / IP40 / IP50 / IP64	51TR1FE	
		4,500	IP20 / IP40 / IP50 / IP64	51TR1JE	
	7-core	1,500	IP20 / IP40 / IP50 / IP64	51TR1C7	
		3,000	IP20 / IP40 / IP50 / IP64	51TR1F7	
		4,500	IP20 / IP40 / IP50 / IP64	51TR1J7	
	no wiring	1,500	IP20 / IP40 / IP50 / IP64	51TR1C0	
		3,000	IP20 / IP40 / IP50 / IP64	51TR1F0	
		4,500	IP20 / IP40 / IP50 / IP64	51TR1J0	
jet-black	14-core	1,500	IP20 / IP40 / IP50	51TR3CE	
		3,000	IP20 / IP40 / IP50	51TR3FE	
		4,500	IP20 / IP40 / IP50	51TR3JE	
	7-core	1,500	IP20 / IP40 / IP50	51TR3C7	
		3,000	IP20 / IP40 / IP50	51TR3F7	
		4,500	IP20 / IP40 / IP50	51TR3J7	
	metallic grey	14-core	1,500	IP20 / IP40 / IP50	51TR6CE
			3,000	IP20 / IP40 / IP50	51TR6FE
			4,500	IP20 / IP40 / IP50	51TR6JE
7-core		1,500	IP20 / IP40 / IP50	51TR6C7	
		3,000	IP20 / IP40 / IP50	51TR6F7	
		4,500	IP20 / IP40	51TR6J7	

Other colour temperatures available on request.

Licross® Recessed

Licross® 11 Recessed IP40

Length	Colour temperature K	Colour rendering CRI	Luminous flux lm	Connected load W	Efficacy lm / W	Ambient temperature °C	Control	Light distribution	L-value/ rated service life 25°C / B50 in hours	Order number
750 mm	4,000	> 80	6,500	39	168	-25 ... +35	DALI	wide	L85 / 100,000	51TL12DE465L
			4,570	29	159	-25 ... +40	DALI	wide	L85 / 100,000	51TL12DE445F
			6,420	40	161	-25 ... +35	DALI	medium	L85 / 100,000	51TL18DE46XL
			4,460	29	155	-25 ... +40	DALI	medium	L85 / 100,000	51TL18DE44XF
			6,530	40	163	-25 ... +40	DALI	narrow	L85 / 100,000	51TL11DE465R
			4,520	29	157	-25 ... +40	DALI	narrow	L85 / 100,000	51TL11DE445F
			4,280	29	147	-25 ... +35	DALI	asymmetric	L85 / 100,000	51TL14DE44XF
			4,500	30	153	-25 ... +35	DALI	double asym.	L85 / 100,000	51TL19DE445F

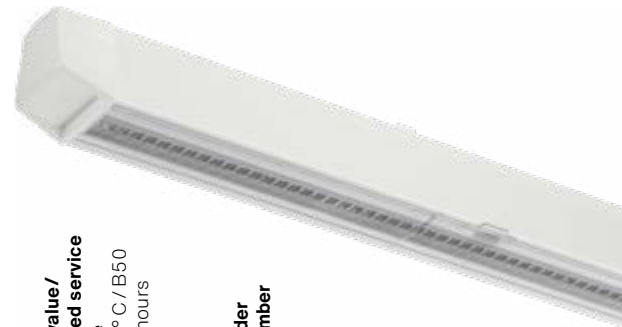

Length	Colour temperature K	Colour rendering CRI	Luminous flux lm	Connected load W	Efficacy lm / W	Ambient temperature °C	Control	Light distribution	L-value / rated service life 25° C / B50 in hours	Order number			
1,500 mm	4,000	> 80	TW	> 80	8,460	57	147	-25 ... +35	DALI TW	wide	L85 / 70,000	51TL12TNT8XW	
			6,430	49	130	-25 ... +35	DALI	diffuse	L85 / 50,000	51TL10DN46XA			
			13,000	76	171	-25 ... +45	DALI	wide	L80 / 100,000	51TL12DN4DXLE			
			13,000	76	171	-25 ... +35	DALI	wide	L85 / 70,000	51TL12DN4DXLD*			
			13,000	76	171	-25 ... +35	DALI	wide	L85 / 70,000	51TL12DN4DXL3S**			
			13,000	76	171	-25 ... +35	DALI	wide	L85 / 70,000	51TL12DN4DXL3C***			
			9,140	55	165	-25 ... +50	DALI	wide	L80 / 100,000	51TL12DN49XFE			
			9,140	55	165	-25 ... +40	DALI	wide	L85 / 70,000	51TL12DN49XFD*			
			9,140	55	165	-25 ... +40	DALI	wide	L85 / 70,000	51TL12DN49XF3S**			
			9,140	55	165	-25 ... +40	DALI	wide	L85 / 70,000	51TL12DN49XF3C***			
			6,420	48	134	-25 ... +35	DALI	wide	L85 / 50,000	51TL12DN46XA			
			12,830	76	169	-25 ... +45	DALI	medium	L80 / 100,000	51TL18DN4C5LE			
			12,830	76	169	-25 ... +30	DALI	medium	L85 / 70,000	51TL18DN4C5LD*			
			8,910	55	161	-25 ... +50	DALI	medium	L80 / 100,000	51TL18DN485FE			
			8,910	55	161	-25 ... +40	DALI	medium	L85 / 70,000	51TL18DN485FD*			
			6,280	48	131	-25 ... +35	DALI	medium	L85 / 50,000	51TL18DN46XA			
			13,060	77	171	-25 ... +40	DALI	narrow	L80 / 100,000	51TL11DN4DXRE			
			13,060	77	171	-25 ... +30	DALI	narrow	L85 / 70,000	51TL11DN4DXRD*			
			9,030	55	163	-25 ... +50	DALI	narrow	L80 / 100,000	51TL11DN49XFE			
			9,030	55	163	-25 ... +40	DALI	narrow	L85 / 70,000	51TL11DN49XFD*			
			8,550	56	152	-25 ... +35	DALI	asymmetric	L85 / 70,000	51TL14DN485FD*			
			9,010	57	158	-25 ... +35	DALI	double asym.	L85 / 70,000	51TL19DN49XFD*			
			12,200	69	177	-35 ... +35	ON / OFF ML CLOi	wide	L100 / 70,000	51TL12CN4CXLD*			
			8,279	48	173	-35 ... +40	ON / OFF ML CLOi	wide	L100 / 70,000	51TL12CN48XFD*			
			12,000	69	175	-35 ... +35	ON / OFF ML CLOi	medium	L100 / 70,000	51TL18CN4CXLD*			
			8,060	48	168	-35 ... +40	ON / OFF ML CLOi	medium	L100 / 70,000	51TL18CN48XFD*			
			12,100	69	176	-35 ... +35	ON / OFF ML CLOi	narrow	L100 / 70,000	51TL11CN4CXRD*			
			8,170	48	170	-35 ... +40	ON / OFF ML CLOi	narrow	L100 / 70,000	51TL11CN48XFD*			
			7,640	48	162	-35 ... +40	ON / OFF ML CLOi	asymmetric	L100 / 70,000	51TL14CN475FD*			
			8,020	49	165	-35 ... +35	ON / OFF ML CLOi	double asym.	L100 / 70,000	51TL19CN48XFD*			
			6,380	48	132	-35 ... +40	ON / OFF	diffuse	L85 / 50,000	51TL107N46XA			
			8,350	48	175	-35 ... +40	ON / OFF	wide	L85 / 70,000	51TL127N48XF			
			6,200	46	136	-35 ... +40	ON / OFF	wide	L85 / 50,000	51TL127N46XA			
			8,150	48	171	-35 ... +40	ON / OFF	medium	L85 / 70,000	51TL187N48XF			
			6,360	48	131	-35 ... +40	ON / OFF	medium	L85 / 50,000	51TL187N46XA			
			8,240	48	173	-35 ... +40	ON / OFF	narrow	L85 / 70,000	51TL117N48XF			
			7,710	48	162	-35 ... +40	ON / OFF	asymmetric	L85 / 70,000	51TL147N475F			
			8,020	48	169	-35 ... +40	ON / OFF	double asym.	L85 / 70,000	51TL197N48XF			
			2,250 mm	4,000	> 80	26,230	150	175	-35 ... +35	DALI	wide	L85 / 100,000	51TL12DV4M1L
						15,420	90	172	-25 ... +35	DALI	wide	L85 / 100,000	51TL12DV4FXF
7,640	42	181				-25 ... +45	DALI	wide	L85 / 100,000	51TL12DV475F			
25,960	150	173				-35 ... +35	DALI	medium	L85 / 100,000	51TL18DV4M5L			
14,980	90	167				-25 ... +35	DALI	medium	L85 / 100,000	51TL18DV4E5F			
8,000	46	176				-25 ... +45	DALI	medium	L85 / 100,000	51TL18DV48XF			
26,170	150	174				-35 ... +35	DALI	narrow	L85 / 100,000	51TL11DV4M1R			
15,190	90	170				-25 ... +35	DALI	narrow	L85 / 100,000	51TL11DV4FXF			
14,200	90	159				-25 ... +35	DALI	asymmetric	L85 / 100,000	51TL14DV4EXF			
14,780	90	165				-25 ... +35	DALI	double asym.	L85 / 100,000	51TL19DV4E5F			
11,510	68	170				-25 ... +40	DALI	double asym.	L85 / 100,000	51TL19DV4B5F			

* DC-capable luminaire versions in accordance with emergency luminaire standard EN 60598-2-22 (also for AC operation); ** with 3 h rechargeable battery, self-test;

*** with 3 h rechargeable battery, central monitoring; Other colour temperatures available on request.

Licross® 21 Recessed IP40

Length	Colour temperature K	Colour rendering CRI	Luminous flux lm	Connected load W	Efficacy lm/W	Ambient temperature °C	Control	Light distribution	L-value/ rated service life 25°C / B50 in hours	Order number
750 mm	4,000	> 80	6,550	43	152	-25 ... +30	DALI	wide	L85 / 50,000	52TL12DE465L
			4,760	32	151	-25 ... +35	DALI	wide	L85 / 50,000	52TL12DE445F
			6,490	43	151	-25 ... +30	DALI	medium	L85 / 50,000	52TL18DE46XL
			4,620	32	147	-25 ... +35	DALI	medium	L85 / 50,000	52TL18DE445F
			6,540	43	152	-25 ... +30	DALI	narrow	L85 / 50,000	52TL11DE465R
			4,690	32	149	-25 ... +35	DALI	narrow	L85 / 50,000	52TL11DE445F
			4,380	32	139	-25 ... +35	DALI	asymmetric	L85 / 50,000	52TL14DE44XF
			4,560	32	145	-25 ... +35	DALI	double asym.	L85 / 50,000	52TL19DE445F
3,500*	> 80	9,020	61	148	-25 ... +35	DALI	wide	L85 / 50,000	52TL12DN19XF	
		8,760	61	144	-25 ... +35	DALI	medium	L85 / 50,000	52TL18DN185F	
		8,310	61	136	-25 ... +35	DALI	asymmetric	L85 / 50,000	52TL14DN18XF	
		8,640	61	142	-25 ... +35	DALI	double asym.	L85 / 50,000	52TL19DN185F	
1,500 mm	4,000	> 80	7,770	60	130	0 ... +35	DALI	diffuse	L85 / 50,000	51TL10DN475A
			16,080	92	174	0 ... +25	DALI	wide	L85 / 50,000	51TL12DN4GXL
			13,110	82	159	-25 ... +30	DALI	wide	L85 / 50,000	52TL12DN4DXL
			10,430	61	172	0 ... +35	DALI	wide	L85 / 50,000	51TL12DN4AXF
			9,520	61	156	-25 ... +35	DALI	wide	L85 / 50,000	52TL12DN495F
			7,920	60	132	0 ... +35	DALI	wide	L85 / 50,000	51TL12DN475A
			15,740	91	172	0 ... +25	DALI	medium	L85 / 50,000	51TL18DN4F5L
			12,970	82	158	-25 ... +30	DALI	medium	L85 / 50,000	52TL18DN4C5L
			10,130	61	167	0 ... +35	DALI	medium	L85 / 50,000	51TL18DN4AXF
			9,250	61	151	-25 ... +35	DALI	medium	L85 / 50,000	52TL18DN49XF
			7,750	60	129	0 ... +35	DALI	medium	L85 / 50,000	51TL18DN475A
			15,870	91	174	0 ... +25	DALI	narrow	L85 / 50,000	51TL11DN4F5R
			13,080	82	159	-25 ... +30	DALI	narrow	L85 / 50,000	52TL11DN4DXR
			10,270	61	169	0 ... +35	DALI	narrow	L85 / 50,000	51TL11DN4AXF
			9,370	61	154	-25 ... +35	DALI	narrow	L85 / 50,000	52TL11DN49XF
			7,850	60	131	0 ... +35	DALI	narrow	L85 / 50,000	51TL11DN475A
			9,600	61	158	0 ... +35	DALI	asymmetric	L85 / 50,000	51TL14DN495F
			8,770	61	144	-25 ... +35	DALI	asymmetric	L85 / 50,000	52TL14DN485F
			7,340	60	122	0 ... +35	DALI	asymmetric	L85 / 50,000	51TL14DN47XA
			10,000	61	164	0 ... +35	DALI	double asym.	L85 / 50,000	51TL19DN4AXF
			9,120	61	149	-25 ... +35	DALI	double asym.	L85 / 50,000	52TL19DN49XF
			7,643	60	129	0 ... +35	DALI	double asym.	L85 / 50,000	51TL19DN475A
			7,930	49	163	-35 ... +40	ON / OFF	wide	L85 / 50,000	52TL127N475F
			7,700	49	158	-35 ... +40	ON / OFF	medium	L85 / 50,000	52TL187N475F
			7,810	49	160	-35 ... +40	ON / OFF	narrow	L85 / 50,000	52TL117N475F
			7,300	49	150	-35 ... +40	ON / OFF	asymmetric	L85 / 50,000	52TL147N47XF
			7,600	49	156	-35 ... +40	ON / OFF	double asym.	L85 / 50,000	52TL197N475F
			11,540	69	169	-35 ... +35	ON / OFF ML CLOi	wide	L100 / 50,000	52TL12CN4B5L
			8,400	51	166	-35 ... +40	ON / OFF ML CLOi	wide	L100 / 50,000	52TL12CN48XF
			11,420	69	167	-35 ... +35	ON / OFF ML CLOi	medium	L100 / 50,000	52TL18CN4BXL
			8,160	51	162	-35 ... +40	ON / OFF ML CLOi	medium	L100 / 50,000	52TL18CN48XF
			11,510	69	168	-35 ... +35	ON / OFF ML CLOi	narrow	L100 / 50,000	52TL11CN4B5R
			8,270	51	164	-35 ... +40	ON / OFF ML CLOi	narrow	L100 / 50,000	52TL11CN48XF
			7,740	51	153	-35 ... +40	ON / OFF ML CLOi	asymmetric	L100 / 50,000	52TL14CN475F
			8,050	51	159	-35 ... +40	ON / OFF ML CLOi	double asym.	L100 / 50,000	52TL19CN48XF
			> 90*	> 80	7,960	61	130	-25 ... +35	DALI	wide
7,730	61	127			-25 ... +35	DALI	medium	L85 / 50,000	52TL18DND75F	
7,330	61	120			-25 ... +35	DALI	asymmetric	L85 / 50,000	52TL14DND7XF	
7,630	61	125			-25 ... +35	DALI	double asym.	L85 / 50,000	52TL19DND75F	

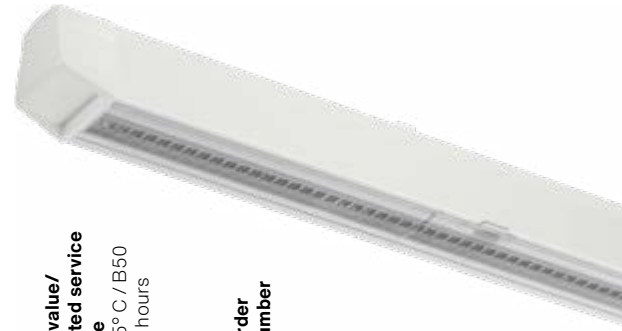

Length	Colour temperature K	Colour rendering CRI	Luminous flux lm	Connected load W	Efficacy lm/W	Ambient temperature °C	Control	Light distribution	L-value/ rated service life 25°C / B50 in hours	Order number
1,500 mm	5,000	> 80	12,950	82	157	-25 ... +30	DALI	wide	L85 / 50,000	52TL12DN5C5L
			9,400	61	154	-25 ... +35	DALI	wide	L85 / 50,000	52TL12DN59XF
			9,130	61	150	-25 ... +35	DALI	medium	L85 / 50,000	52TL18DN59XF
			12,920	82	157	-25 ... +30	DALI	narrow	L85 / 50,000	52TL11DN5C5R
			9,260	61	152	-25 ... +35	DALI	narrow	L85 / 50,000	52TL11DN59XF
			8,660	61	142	-25 ... +35	DALI	asymmetric	L85 / 50,000	52TL14DN585F
	> 90*	7,970	61	131	-25 ... +35	DALI	wide	L85 / 50,000	52TL12DNE75F	
		7,740	61	127	-25 ... +35	DALI	medium	L85 / 50,000	52TL18DNE75F	
		7,340	61	120	-25 ... +35	DALI	asymmetric	L85 / 50,000	52TL14DNE7XF	
		20,420	127	161	-35 ... +30	DALI	wide	L85 / 50,000	52TL12DV4LXL	
		14,290	91	157	-25 ... +35	DALI	wide	L85 / 50,000	52TL12DV4EXF	
		8,870	53	167	-25 ... +45	DALI	wide	L85 / 50,000	52TL12DV485F	
2,250 mm	4,000	> 80	20,200	127	159	-35 ... +30	DALI	medium	L85 / 50,000	52TL18DV4LXL
			13,880	91	153	-25 ... +35	DALI	medium	L85 / 50,000	52TL18DV4D5F
			6,200	38	164	-25 ... +50	DALI	medium	L85 / 50,000	52TL18DV46XF
			20,370	127	161	-35 ... +30	DALI	narrow	L85 / 50,000	52TL11DV4LXR
			14,070	91	155	-25 ... +35	DALI	narrow	L85 / 50,000	52TL11DV4EXF
			13,160	91	145	-25 ... +35	DALI	asymmetric	L85 / 50,000	52TL14DV4DXF
			13,700	91	151	-25 ... +35	DALI	double asym.	L85 / 50,000	52TL19DV4D5F
			11,510	74	155	-25 ... +40	DALI	double asym.	L85 / 50,000	52TL19DV4BXF

* Delivery time on request; Other colour temperatures available on request.

Licross® Protected

Licross® 11 Protected IP50

Length	Colour temperature K	Colour rendering CRI	Luminous flux lm	Connected load W	Efficacy lm / W	Ambient temperature °C	Control	Light distribution	L-value/ rated service life 25° C / B50 in hours	Order number
1,500 mm	TW	> 80	7,740	57	135	-25 ... +40	DALI TW, DT 8	wide	L85 / 70,000	51TS12TNT75W
			13,360	86	155	-25 ... +35	DALI	wide	L85 / 70,000	51TS12DN4DXLD*
			8,470	56	151	-25 ... +40	DALI	wide	L85 / 70,000	51TS12DN48XFD*
	4,000	> 80	6,250	53	119	-25 ... +40	DALI	wide	L85 / 50,000	51TS12DN46XA
			7,690	48	162	-35 ... +45	ON / OFF	wide	L85 / 70,000	51TS127N475F
			6,250	52	121	-35 ... +45	ON / OFF	wide	L85 / 50,000	51TS127N46XA
			12,600	79	160	-35 ... +40	ON / OFF ML CLOi	wide	L100 / 70,000	51TS12CN4C5LD*
			7,680	49	157	-35 ... +40	ON / OFF ML CLOi	wide	L100 / 70,000	51TS12CN475FD*

Other colour temperatures available on request.

Licross® 11 Protected IP64

Length	Colour temperature K	Colour rendering CRI	Luminous flux lm	Connected load W	Efficacy lm / W	Ambient temperature °C	Control	Light distribution	L-value/ rated service life 25° C / B50 in hours	Order number	
1,500 mm	4,000	> 80	TW	8,100	57	141	-35 ... +40	DALI TW	wide	L85 / 70,000	51TP12TNT8XW
			14,070	86	163	-25 ... +35	DALI	wide	L85 / 70,000	51TP12DN4EXLD*	
			14,070	86	163	-25 ... +35	DALI	wide	L85 / 70,000	51TP12DN4EXL3S**	
			14,070	86	163	-25 ... +35	DALI	wide	L85 / 70,000	51TP12DN4EXL3C***	
			9,020	56	161	-25 ... +40	DALI	wide	L85 / 70,000	51TP12DN49XFD*	
			9,020	56	161	-25 ... +40	DALI	wide	L85 / 70,000	51TP12DN49XF3S**	
			9,020	56	161	-25 ... +40	DALI	wide	L85 / 70,000	51TP12DN49XF3C***	
			6,470	51	126	-25 ... +40	DALI	wide	L85 / 50,000	51TP12DN46XA	
			14,140	84	168	-25 ... +35	DALI	narrow	L85 / 70,000	51TP11DN4EXRD*	
			9,080	57	160	-25 ... +40	DALI	narrow	L85 / 70,000	51TP11DN49XFD*	
			14,170	84	168	-25 ... +35	DALI	extr. narrow	L85 / 70,000	51TP13DN4EXRD*	
			13,270	79	169	-35 ... +40	ON / OFF ML CLOi	wide	L100 / 70,000	51TP12CN4DXLD*	
			8,180	49	167	-35 ... +40	ON / OFF ML CLOi	wide	L100 / 70,000	51TP12CN48XFD*	
			13,240	76	173	-35 ... +40	ON / OFF ML CLOi	narrow	L100 / 70,000	51TP11CN4DXRD*	
			8,140	49	166	-35 ... +40	ON / OFF ML CLOi	narrow	L100 / 70,000	51TP11CN48XFD*	
			13,280	76	174	-35 ... +40	ON / OFF ML CLOi	extr. narrow	L100 / 70,000	51TP13CN4DXRD*	
			8,110	48	170	-35 ... +45	ON / OFF	wide	L85 / 70,000	51TP127N48XF	
			6,290	48	130	-35 ... +45	ON / OFF	wide	L85 / 50,000	51TP127N46XA	
8,070	48	170	-35 ... +45	ON / OFF	narrow	L85 / 70,000	51TP117N48XF				

* DC-capable luminaire variants in accordance with emergency luminaire standard EN 60598-2-22 (also for AC operation); ** with 3 h rechargeable battery, self-test;

*** with 3 h rechargeable battery, central monitoring; Other colour temperatures available on request.



Licross® 21 Protected IP50

Length	Colour temperature K	Colour rendering CRI	Luminous flux lm	Connected load W	Efficacy lm/W	Ambient temperature °C	Control	Light distribution	L-value/ rated service life 25°C / B50 in hours	Order number
1,500 mm	4,000	> 80	14,710	91	161	0 ... +30	DALI	wide	L85 / 50,000	51TS12DN4E5L
			12,160	83	148	-25 ... +35	DALI	wide	L85 / 50,000	52TS12DN4CXL
			9,500	61	156	0 ... +40	DALI	wide	L85 / 50,000	51TS12DN495F
			8,670	61	142	-25 ... +40	DALI	wide	L85 / 50,000	52TS12DN485F
			7,450	60	124	0 ... +40	DALI	wide	L85 / 50,000	51TS12DN47XA
			10,690	69	156	-35 ... +40	ON / OFF ML CLOi	wide	L100 / 50,000	52TS12CN4A5L
			7,650	51	152	-35 ... +45	ON / OFF ML CLOi	wide	L100 / 50,000	52TS12CN475F
	4,000	> 90*	7,230	49	149	-35 ... +45	ON / OFF	wide	L85 / 50,000	52TS127N47XF
	5,000	> 90*	7,240	61	119	-25 ... +40	DALI	wide	L85 / 50,000	52TS12DND7XF
	5,000	> 90*	7,250	61	119	-25 ... +40	DALI	wide	L85 / 50,000	52TS12DNE7XF

* Delivery time on request; Other colour temperatures available on request.

Licross® 21 Protected IP54

Length	Colour temperature K	Colour rendering CRI	Luminous flux lm	Connected load W	Efficacy lm/W	Ambient temperature °C	Control	Light distribution	L-value/ rated service life 25°C / B50 in hours	Order number
1,500 mm	4,000	> 80	12,810	83	155	-25 ... +35	DALI	wide	L85 / 50,000	52TD12DN4C5L
			9,220	61	151	-25 ... +40	DALI	wide	L85 / 50,000	52TD12DN49XF
			13,010	83	158	-25 ... +35	DALI	narrow	L85 / 50,000	52TD11DN4DXR
			9,180	61	151	-25 ... +40	DALI	narrow	L85 / 50,000	52TD11DN49XF
			11,260	69	164	-35 ... +40	ON / OFF ML CLOi	wide	L100 / 50,000	52TD12CN4BXL
			8,150	51	161	-35 ... +45	ON / OFF ML CLOi	wide	L100 / 50,000	52TD12CN48XF
			7,690	49	158	-35 ... +45	ON / OFF	wide	L85 / 50,000	52TD127N475F
	4,000	> 90*	7,710	61	127	-25 ... +40	DALI	wide	L85 / 50,000	52TD12DND75F
	5,000	> 80	9,110	61	150	-25 ... +40	DALI	wide	L85 / 50,000	52TD12DN59XF
	5,000	> 90*	9,070	61	149	-25 ... +40	DALI	narrow	L85 / 50,000	52TD11DN59XF
5,000	> 90*	7,720	61	127	-25 ... +40	DALI	wide	L85 / 50,000	52TD12DNE75F	

* Delivery time on request; Other colour temperatures available on request.

Licross® Performance



Licross® 11 Performance IP50

Length	Colour temperature K	Colour rendering CRI	Luminous flux lm	Connected load W	Efficacy lm / W	Ambient temperature °C	Control	Light distribution	L-value/ rated service life 25°C / B50 in hours	Order number
1,500 mm	TW	> 80	8,190	57	143	-25 ... +40	DALI TW	direct / indirect	L85 / 70,000	51TS16TNT8XW
	4,000	> 80	14,250	86	166	-25 ... +45	DALI	direct / indirect	L80 / 100,000	51TS16DN4EXLE
			14,250	86	166	-25 ... +35	DALI	direct / indirect	L85 / 70,000	51TS16DN4EXLD*
			14,250	86	166	-25 ... +35	DALI	direct / indirect	L85 / 70,000	51TS16DN4EXL3S**
			14,250	86	166	-25 ... +35	DALI	direct / indirect	L85 / 70,000	51TS16DN4EXL3C***
			9,140	56	163	-25 ... +50	DALI	direct / indirect	L80 / 100,000	51TS16DN49XFE
			9,140	56	163	-25 ... +40	DALI	direct / indirect	L85 / 70,000	51TS16DN49XFD*
			9,140	56	163	-25 ... +40	DALI	direct / indirect	L85 / 70,000	51TS16DN49XF3S**
			9,140	56	163	-25 ... +40	DALI	direct / indirect	L85 / 70,000	51TS16DN49XF3C***
			13,440	79	171	-35 ... +40	ON / OFF ML CLOi	direct / indirect	L100 / 70,000	51TS16CN4DXLD*
			8,280	49	169	-35 ... +40	ON / OFF ML CLOi	direct / indirect	L100 / 70,000	51TS16CN48XFD*
	8,210	48	173	-35 ... +45	ON / OFF	direct / indirect	L85 / 70,000	51TS167N48XF		

* DC-capable luminaire variants in accordance with emergency luminaire standard EN 60598-2-22 (also for AC operation); ** with 3 h rechargeable battery, self-test;

*** with 3 h rechargeable battery, central monitoring; Other colour temperatures available on request.

Licross® 21 Performance IP50

Length	Colour temperature K	Colour rendering CRI	Luminous flux lm	Connected load W	Efficacy lm / W	Ambient temperature °C	Control	Light distribution	L-value/ rated service life 25°C / B50 in hours	Order number
1,500 mm	4,000	> 80	12,970	83	157	-25 ... +35	DALI	direct / indirect	L85 / 50,000	52TS16DN4C5L
			9,340	61	153	-25 ... +40	DALI	direct / indirect	L85 / 50,000	52TS16DN49XF
			11,400	69	166	-35 ... +40	ON / OFF ML CLOi	direct / indirect	L100 / 50,000	52TS16CN4BXL
			8,260	51	164	-35 ... +45	ON / OFF ML CLOi	direct / indirect	L100 / 50,000	52TS16CN48XF
			7,790	49	160	-35 ... +45	ON / OFF	direct / indirect	L85 / 50,000	52TS167N475F
	4,000	> 90*	10,830	82	131	-25 ... +35	DALI	direct / indirect	L85 / 50,000	52TS16DND45L
			7,810	61	128	-25 ... +40	DALI	direct / indirect	L85 / 50,000	52TS16DND75F
			5,000	> 80	9,230	61	152	-25 ... +40	DALI	direct / indirect
	> 90*	7,820		61	128	-25 ... +40	DALI	direct / indirect	L85 / 50,000	52TS16DNE75F

* Delivery time on request.

Licross® Shelf-/ Wallwasher



Colour	Colour temperature K	Colour rendering CRI	Luminous flux lm	Connected load W	Efficacy lm / W	Control	Light distribution	L-value/ rated service life 25° C / B50 in hours	Order number
white	3,000	> 80	5,120	45	114	ON / OFF	1	L80 / 50,000	51TH1S7D36XA
	4,000	> 80	5,360	45	119	ON / OFF	1	L80 / 50,000	51TH1S7D46XA
	3,000	> 80	5,120	45	114	DALI	1	L80 / 50,000	51TH1SDD36XA
	4,000	> 80	5,360	45	119	DALI	1	L80 / 50,000	51TH1SDD46XA
	3,000	> 80	5,030	45	112	ON / OFF	2	L80 / 50,000	51TH1W7D36XA
	4,000	> 80	5,270	45	117	ON / OFF	2	L80 / 50,000	51TH1W7D46XA
	3,000	> 80	5,030	45	112	DALI	2	L80 / 50,000	51TH1WDD36XA
	4,000	> 80	5,270	45	117	DALI	2	L80 / 50,000	51TH1WDD46XA
jet-black	3,000	> 80	5,120	45	114	ON / OFF	1	L80 / 50,000	51TH3S7D36XA
	4,000	> 80	5,360	45	119	ON / OFF	1	L80 / 50,000	51TH3S7D46XA
	3,000	> 80	5,120	45	114	DALI	1	L80 / 50,000	51TH3SDD36XA
	4,000	> 80	5,360	45	119	DALI	1	L80 / 50,000	51TH3SDD46XA
	3,000	> 80	5,030	45	112	ON / OFF	2	L80 / 50,000	51TH3W7D36XA
	4,000	> 80	5,270	45	117	ON / OFF	2	L80 / 50,000	51TH3W7D46XA
	3,000	> 80	5,030	45	112	DALI	2	L80 / 50,000	51TH3WDD36XA
	4,000	> 80	5,270	45	117	DALI	2	L80 / 50,000	51TH3WDD46XA
metallic grey	3,000	> 80	5,120	45	114	ON / OFF	1	L80 / 50,000	51TH6S7D36XA
	4,000	> 80	5,360	45	119	ON / OFF	1	L80 / 50,000	51TH6S7D46XA
	3,000	> 80	5,120	45	114	DALI	1	L80 / 50,000	51TH6SDD36XA
	4,000	> 80	5,360	45	119	DALI	1	L80 / 50,000	51TH6SDD46XA
	3,000	> 80	5,030	45	112	ON / OFF	2	L80 / 50,000	51TH6W7D36XA
	4,000	> 80	5,270	45	117	ON / OFF	2	L80 / 50,000	51TH6W7D46XA
	3,000	> 80	5,030	45	112	DALI	2	L80 / 50,000	51TH6WDD36XA
	4,000	> 80	5,270	45	117	DALI	2	L80 / 50,000	51TH6WDD46XA

1 = asymmetrical distribution, Shelfwasher, inclination 0° / -5° / +5°; 2 = asymmetrical distribution, Wallwasher, inclination 0° / -5° / +5°
Other colour temperatures available on request.

Licross[®] Spot 31



Length	Colour	Colour temperature K	Colour rendering CRI	Luminous flux lm	Connected load W	Efficacy lm/W	Control	Beam angle	L-value/ rated service life 25°C / B50 in hours	Order number
300 mm	white	3,000	> 90	4,000	40	100	DALI	24°	L80 / 50,000	51TF12DAB4A
				4,000	40	100	DALI	36°	L80 / 50,000	51TF13DAB4A
				4,000	40	100	ON / OFF	24°	L80 / 50,000	51TF127AB4A
				4,000	40	100	ON / OFF	36°	L80 / 50,000	51TF137AB4A
		4,000	> 80	4,800	40	120	DALI	24°	L80 / 50,000	51TF12DA44A
				4,800	40	120	DALI	36°	L80 / 50,000	51TF13DA44A
				4,800	40	120	ON / OFF	24°	L80 / 50,000	51TF127A44A
				4,800	40	120	ON / OFF	36°	L80 / 50,000	51TF137A44A
	jet-black	3,000	> 90	4,000	40	100	DALI	24°	L80 / 50,000	51TF32DAB4A
				4,000	40	100	DALI	36°	L80 / 50,000	51TF33DAB4A
				4,000	40	100	ON / OFF	24°	L80 / 50,000	51TF327AB4A
				4,000	40	100	ON / OFF	36°	L80 / 50,000	51TF337AB4A
		4,000	> 80	4,800	40	120	DALI	24°	L80 / 50,000	51TF32DA44A
				4,800	40	120	DALI	36°	L80 / 50,000	51TF33DA44A
				4,800	40	120	ON / OFF	24°	L80 / 50,000	51TF327A44A
				4,800	40	120	ON / OFF	36°	L80 / 50,000	51TF337A44A

Licross® Accessories

Basics

Accessories	Details	Length mm	Colour	Protection class	Order number
Blank cover	Material: PC+ABS	1,500	weiß	IP40	59TL1A
Blank cover	Material: PC+ABS	1,500	metallic grey	IP40	59TL6A
Blank cover	Material: PC+ABS	1,500	jet-black	IP40	59TL3A
Blank cover	Material: PC+ABS	1,500	weiß	IP50 / IP64	59TP1A
2 × end cap & 1 × infeed socket	Material: PC; for trunking rail IP20	40	weiß	IP20	59TL1S
2 × end cap & 1 × infeed socket	Material: PC; for trunking rail IP20	40	metallic grey	IP20	59TL6S
2 × end cap & 1 × infeed socket	Material: PC; for trunking rail IP20	40	jet-black	IP20	59TL3S
2 × end cap & 1 × infeed socket	Material: PC; for trunking rail IP40 / 50 / 64	40	weiß	IP40 / IP50 / IP64	59TP1S
Joint gasket		-	weiß	IP64	59TP1C

Hanger

Accessories	Details	Order number
Ceiling mounting	Material: Spring steel V2A, glossy	59TR9D
Ceiling mounting with caddy clip	Material: Spring steel V2A, glossy	59TR9C
Chain suspension, with safety hook, with height adjustment	Material: Spring steel V2A, glossy	59TR9K
Single-wire suspension, wire Ø 1.5 mm with loop, length: 2,000 mm, height adjustment	Material: Spring steel V2A, glossy	59TR9R
Single-wire suspension, wire Ø 1.5 mm with loop, length: 5,000 mm, height adjustment	Material: Spring steel V2A, glossy	59TR9R05
Single-wire suspension, without wire (for Ø 1.5 mm), height adjustment	Material: Spring steel V2A, glossy	59TR9RA
Single-wire suspension, wire Ø 1.5 mm with caddy clip, length: 2,000 mm, height adjustment	Material: Spring steel V2A, glossy	59TR9RC
Single-wire suspension, wire Ø 1.5 mm with caddy clip, length: 3,000 mm, height adjustment	Material: Spring steel V2A, glossy	59TR9RC3
Single-wire suspension, wire Ø 1.5 mm with caddy clip, length: 5,000 mm, height adjustment	Material: Spring steel V2A, glossy	59TR9RC5
Single-wire suspension, wire Ø 1.5 mm with ceiling fastening element, length: 2,000 mm, height adjustment	Material: Spring steel V2A, glossy	59TR9RS
Single-wire suspension, wire Ø 1.5 mm with ceiling fastening element, length: 5,000 mm, height adjustment	Material: Spring steel V2A, glossy	59TR9RS5

Reflectors

Accessories	Details	Order number
Reflectors for Shelf- / Wallwashers for aisle illumination	Plastic, silver coated	59TH6G0A000A

Multifunctional inserts

Accessories	Details	Order number
Multi-insert	Colour: white, IP20, 500 mm	56TL1M
	Colour: jet-black, IP20, 500 mm	56TL3M
	Colour: metallic grey, IP20, 500 mm	56TL6M
Plate rectangular	Colour: uncoated aluminium sheet	59TL9MPS
Plate linear	Colour: uncoated aluminium sheet	59TL9MPN
Adapter for other products or emergency lighting	Electrical adapter, colour: white, IP20	56TL1TA
	Mechanical adapter, colour: white, IP20	56TL1TM
Adapter for loudspeaker	Colour: white	56TL1LT

Cable duct

Accessories	Details	Order number
Cable duct	Colour: white, 3,000 mm	59TR1DF

Feed-in

Accessories	Details	Length mm	Colour	Protection rating	Order number
Infeed module	Infeed module for up to 7-core rail, with pre-wired terminals incl. blank cover and 2 × end cap	300	white	IP20 / IP40	59TL1FN7
		300	metallic grey	IP20 / IP40	59TL6FN7
		300	jet-black	IP20 / IP40	59TL3FN7
		300	white	IP50 / IP64	59TP1FN7
	Infeed module for up to 14-core rail, with pre-wired terminals incl. blank cover and 2 × end cap	450	white	IP20 / IP40	59TL1FNE
		450	metallic grey	IP20 / IP40	59TL6FNE
		450	jet-black	IP20 / IP40	59TL3FNE
		450	white	IP50 / IP64	59TP1FNE
Infeed socket, spare part	-	-	IP20 / IP40	59TL3FNK	

Centre feed-in

Accessories	Details	Length mm	Colour	Protection rating	Order number
Centre infeed module	Centre infeed module (2 × infeed) for up to 7-core rail, with pre-wired terminals incl. blank cover	450	white	IP20 / IP40	59TL1CN7
		450	metallic grey	IP20 / IP40	59TL6CN7
		450	jet-black	IP20 / IP40	59TL3CN7
		450	white	IP50 / IP64	59TP1CN7
	Centre infeed module (2 × infeed) for up to 14-core rail, with pre-wired terminals incl. blank cover	650	white	IP20 / IP40	59TL1CNE
		650	metallic grey	IP20 / IP40	59TL6CNE
		650	jet-black	IP20 / IP40	59TL3CNE
		650	white	IP50 / IP64	59TP1CNE

Centre feed-in /-out

Accessories	Details	Length mm	Colour	Protection rating	Order number
Centre feed module	Centre feed module (feed-in /-out) for up to 7-core rail, with pre-wired terminals incl. blank cover	450	white	IP20 / IP40	59TL1MN7
		450	metallic grey	IP20 / IP40	59TL6MN7
		450	jet-black	IP20 / IP40	59TL3MN7
		450	white	IP50 / IP64	59TP1MN7
	Centre feed module (feed-in /-out) for up to 14-core rail, with pre-wired terminals incl. blank cover	650	white	IP20 / IP40	59TL1MNE
		650	metallic grey	IP20 / IP40	59TL6MNE
		650	jet-black	IP20 / IP40	59TL3MNE
		650	white	IP50 / IP64	59TP1MNE

Feed-out

Accessories	Details	Length mm	Colour	Protection rating	Order number	
Feed-out module	Feed-out module for up to 7-core rail, with pre-wired terminals incl. blank cover and 2 × end cap	300	white	IP20 / IP40	59TL1FT7	
		300	metallic grey	IP20 / IP40	59TL6FT7	
		300	jet-black	IP20 / IP40	59TL3FT7	
		300	white	IP50 / IP64	59TP1FT7	
	Feed-out module for up to 14-core rail, with pre-wired terminals incl. blank cover and 2 × end cap	450	white	IP20 / IP40	59TL1FTE	
		450	metallic grey	IP20 / IP40	59TL6FTE	
		450	jet-black	IP20 / IP40	59TL3FTE	
		450	white	IP50 / IP64	59TP1FTE	
		Feed-out socket, spare part	-	-	IP20 / IP40	59TL3FTK

SITECO Services

All-round carefree with a strong partner network.

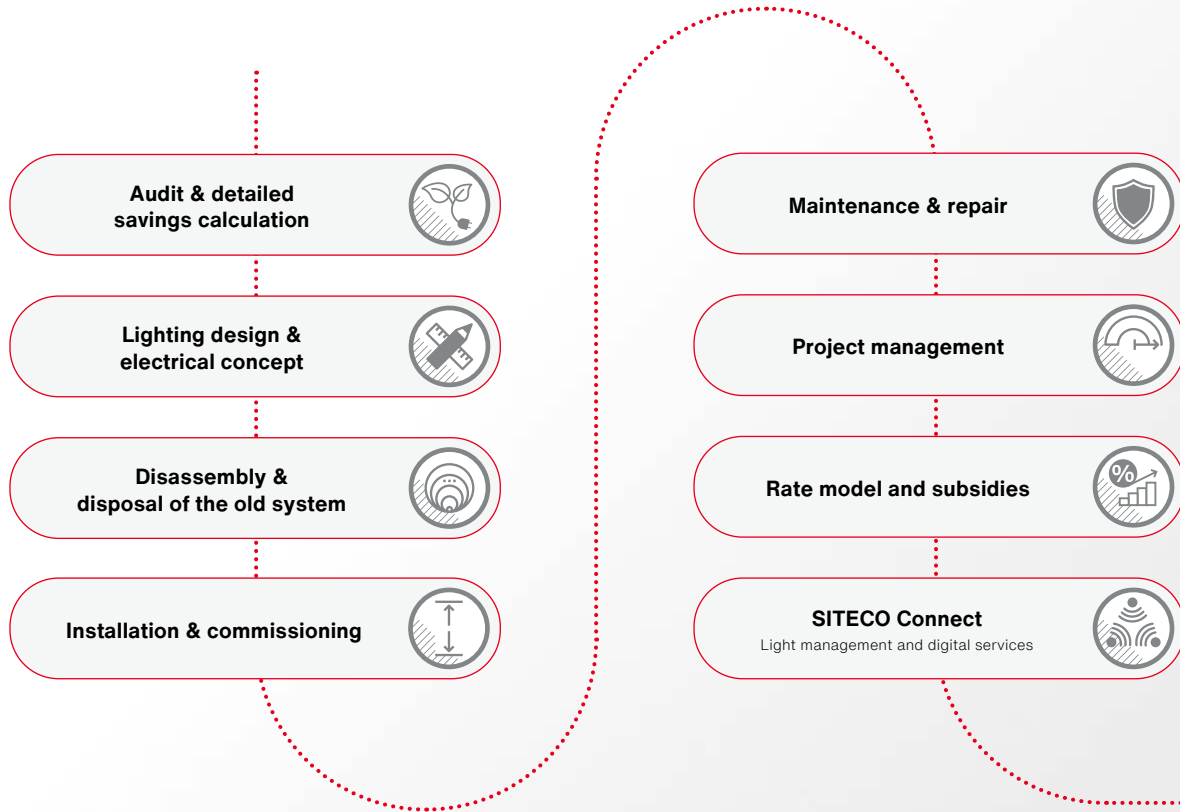

With our service model, you get turnkey solutions from a single source – from planning and installation to maintenance and financing. The choice is yours: from pure lighting to the “all-round carefree package”.

SITECO is your planning and development partner for every lighting solution.



Extend, control and monitor Licross® intelligently: With SITECO Connect.

From simple plug-and-play control to integrated software systems and SITECO HCL^{live} applications – SITECO Connect offers you perfectly tailored solutions for local or central control, monitoring and the use of your lighting installation as a data highway. We are happy to accompany you through the entire process: planning, configuration and commissioning.

For more information, visit www.siteco.com/solutions/siteco-connect

“Today we control locally,
but soon across
multiple locations.”

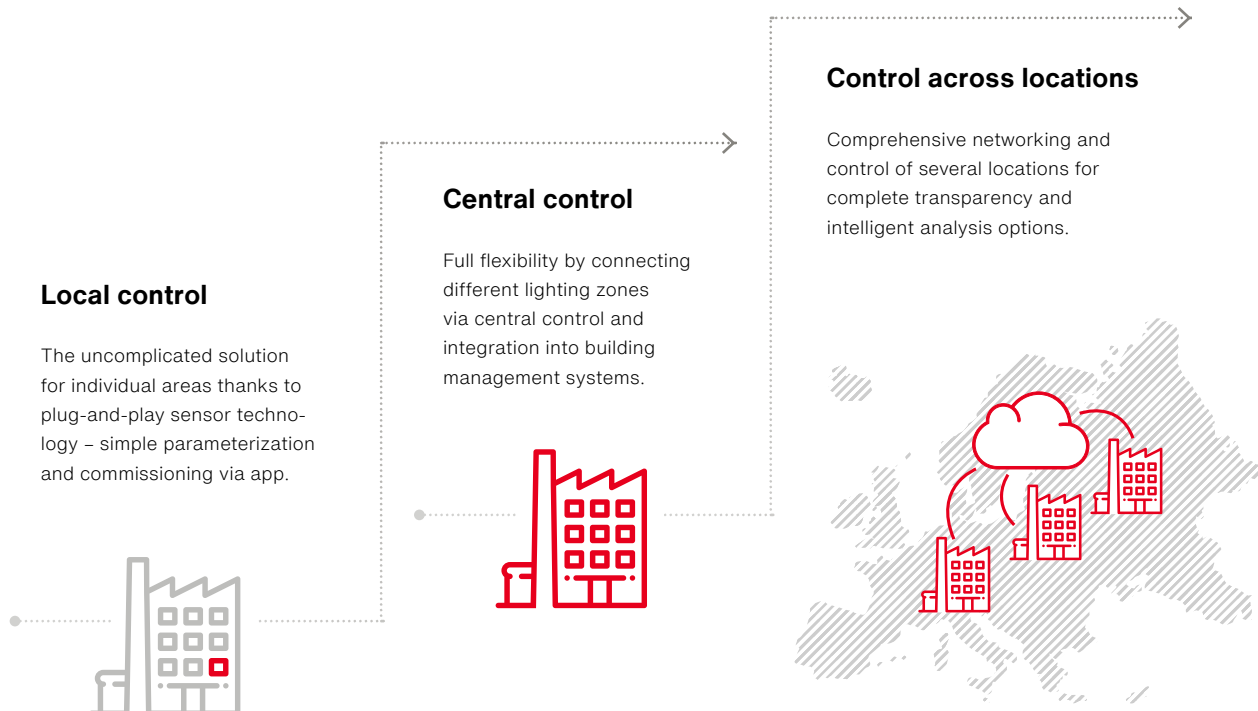

Not open for debate:
Everything has to be possible.

Now or later. We create the infrastructure that leaves all your options open. From the simple plug-and-play control to the fully intergrated building management system – SITECO Connect delivers tailor-made solutions. And we accompany you through the entire process: planning, programming and commissioning.

SITECO Connect for next-level digital solutions.

Licross® Accessories

Sensor interfaces

Application	Control	Function	Licross® sensor			
			Licross® sensor head ¹⁾		Licross® TS sensor interface ¹⁾	
			Type	Order number	Type	Order number
For narrow rooms e.g. corridors Mh = 2 ... 5 m	SITECO Connect I/O DALI2 control system on site	DALI2 ⁴⁾	S	56TL1FCSA	PR1-S	59US1HXSPR1A
	DALI Professional RTC	DALI	MC	56TL1FDSA	PR1-M	59US1HXMPR1A
	locally dimmable ^{2) 3)}	Master	MD	56TL1FCMA	PR1-S	59US1HXSPR1A
	locally dimmable ^{2) 3)}	Slave	S	56TL1FCSA	PR1-S	59US1HXSPR1A
	locally switchable ³⁾	Master	MS	56TL1FAMA	PR1-M	59US1HXMPR1A
For rack and highbay storage Mh = 4 ... 14 m	SITECO Connect I/O DALI2 control system on site	DALI2 ⁴⁾	S	56TL1FCSA	PR2-S	59US1HXSPR2A
	DALI Professional RTC	DALI	MC	56TL1FDSA	PR2-M	59US1HXMPR2A
	locally dimmable ^{2) 3)}	Master	MD	56TL1FCMA	PR2-S	59US1HXSPR2A
	locally dimmable ^{2) 3)}	Slave	S	56TL1FCSA	PR2-S	59US1HXSPR2A
	locally switchable ³⁾	Master	MS	56TL1FAMA	PR2-M	59US1HXMPR2A
For low rooms e.g. logistics zones Mh = 2,5 ... 4 m	SITECO Connect I/O DALI2 control system on site	DALI2 ⁴⁾	S	56TL1FCSA	PC1-S	59US1HXSPC1A
	DALI Professional RTC	DALI	MC	56TL1FDSA	PC1-M	59US1HXMPC1A
	locally dimmable ^{2) 3)}	Master	MD	56TL1FCMA	PC1-S	59US1HXSPC1A
	locally dimmable ^{2) 3)}	Slave	S	56TL1FCSA	PC1-S	59US1HXSPC1A
	locally switchable ³⁾	Master	MS	56TL1FAMA	PC1-M	59US1HXMPC1A
For high rooms e.g. logistics zones Mh = 4 ... 14 m	SITECO Connect I/O DALI2 control system on site	DALI2 ⁴⁾	S	56TL1FCSA	PC5-S	59US1HXSPC5A
	DALI Professional RTC	DALI	MC	56TL1FDSA	PC5-M	59US1HXMPC5A
	locally dimmable ^{2) 3)}	Master	MD	56TL1FCMA	PC5-S	59US1HXSPC5A
	locally dimmable ^{2) 3)}	Slave	S	56TL1FCSA	PC5-S	59US1HXSPC5A
	locally switchable ³⁾	Master	MS	56TL1FAMA	PC5-M	59US1HXMPC5A
Light sensor for daylight detection low rooms Mh = 2,5 ... 4 m	SITECO Connect I/O DALI2 control system on site	DALI2 ⁴⁾	S	56TL1FCSA	D2	59TS1HXSD2A

1) A Licross® sensor consists of a Licross® sensor head and a Licross® trunking sensor interface.

2) Control locally dimmable, consisting of master (control, detection) and slave (extension of detection area).

3) Commissioning with Smart Remote 59UC3RCA.

4) According to the latest DALI2 certification IEC 62386 parts 101, 103, 303 and 304.

Sensor modules

Application	Control	Function	Licross® sensor module	
			Type	Order number
For shelf systems with mesh bases	locally dimmable ^{1) 2)}	Master	HE1-M	56TL1MBMHE1A
		Slave	HE1-S	56TL1MBSHE1A
Light sensor for daylight control, low rooms Mh = 2.5 ... 6 m	locally dimmable ^{1) 2) 4)}	DALI Professional RTC ²⁾	DALI	56TL1MBSHE1A
		DALI Professional RTC	DALI	56TL1MBSHE1A
Light sensor for daylight control, high rooms Mh = 4 ... 12 m	DALI Professional RTC	DALI	D1	56TL1MDS1A
		DALI	D1	56TL1MDS1A
Office and classroom Mh = 2 ... 3.5 m, presence detection 16 m ²	SITECO Connect I/O DALI2 control system on site	DALI2 ³⁾	PC3-S	white: 56TL1MDSPC3A black: 56TL3MDSPC3A silver: 56TL6MDSPC3A
		DALI2 ³⁾	PS2-S	white: 56TL1MDSPS2A
Office and classroom Mh = 2 ... 3.5 m, presence detection 64 m ²	SITECO Connect I/O DALI2 control system on site	DALI2 ³⁾	PS2-S	white: 56TL1MDSPS2A
		DALI2 ³⁾	PS2-S	white: 56TL1MDSPS2A

1) Control locally dimmable, consisting of master (control, detection) and slave (extension of detection area).

2) Commissioning with Smart Remote 59UC3RCA.

3) According to the latest DALI2 certification IEC 62386 parts 101, 103, 303 and 304.

4) DALI push button interface 5LZ904731 is essential for manual control!

Project: SITECO, Traunreut, Germany
Product: Licross® Trunking System



Contact.

Siteco GmbH

Georg-Simon-Ohm-Str. 50
83301 Traunreut, Deutschland
Phone +49 8669 330
info@siteco.com

Technical support

Phone +49 8669 338 44
technicalsupport@siteco.com

siteco.com