

siteco

Types,
data sheets,
configuration –
all at a glance:

**Urban luminaires –
individual parts**



Style. Pure form.
Precision. Elegance.
Pure form. Style.
Elegance. Precision.

Urban luminaires with Module 540.

The classic with a future.

The future of urban and park lights. Ready when you are.

Every city is different, but all want to be attractive and inviting. SITECO urban and park luminaires can play a decisive role in adding a certain flair to your city. Our luminaires are effective day and night, create aesthetic accents and look perfect when combined with design masts.

But the best part is what's inside: All luminaires contain the latest generation of Module 540, which is also a perfect solution for refurbishing old systems. Because this module packs a punch: It has, for example, iQ, our new, patented luminaire electronics that equip your light with a host of new functions and forward-looking control options. SITECO transports cherished design classics not just into the age of LED, but right into the future.

**Urban lighting with Module 540 – classic on the outside,
revolutionary on the inside.**

Urban portfolio

Complete modular system of design classics that range from mushroom luminaires and lanterns to modern light pillars. That means always finding a suitable light pillar: Our portfolio is guaranteed to offer a suitable solution that works with every architectural environment and addresses all functional requirements.

Inner qualities

Module 540 relies on the best SITECO has to offer: the Streetlight SL 11 lighting technology – including iQ. That's digital, highly talented lighting on a whole new level.

Off into the future

An uncomplicated refurbishment solution, the Module 540 tidies up old systems with outdated technology. The look stays the same, while the light becomes future-proof and controllable. That's how sustainability works.

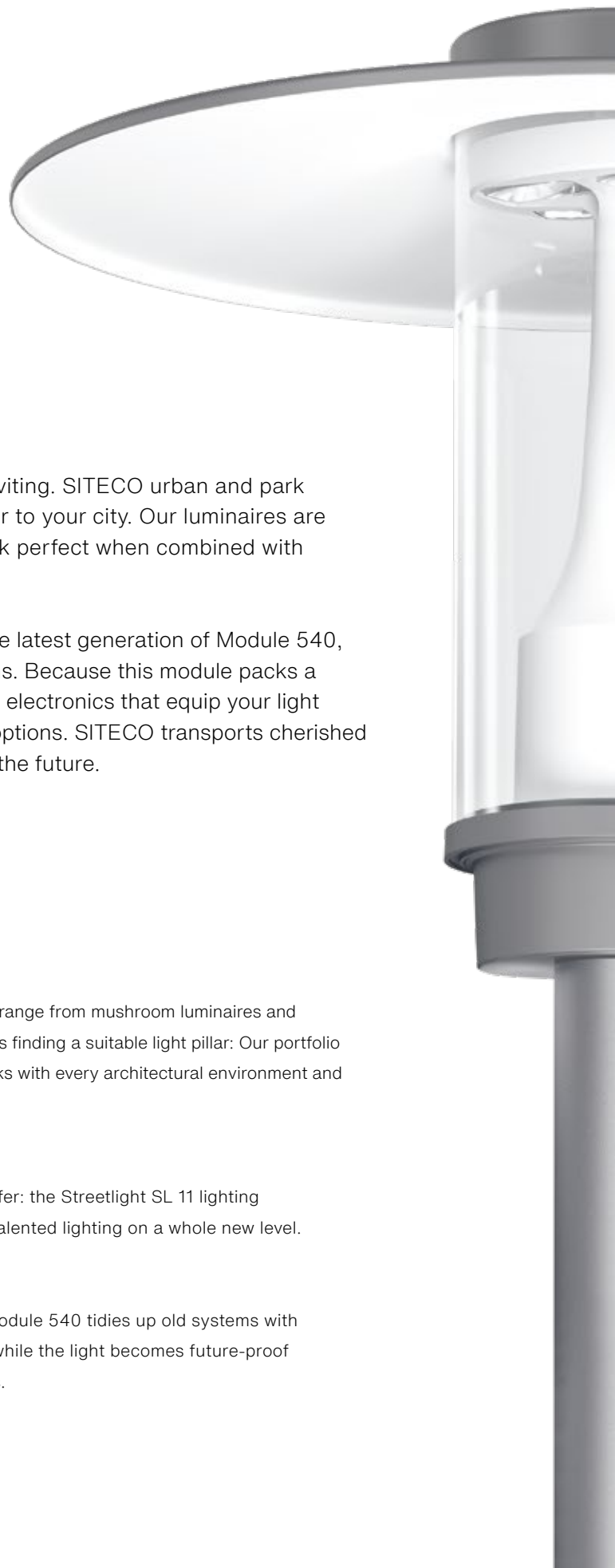



Already fully loaded with control and diagnostic features for individual light distribution options, maintenance at Formula 1 speeds, and much more.

Smart Interface

Standardized interfaces for easy plug & play installation of many compatible radio control systems and sensors.

- **Maximum flexibility thanks to a range of luminaires that help you meet the architectural requirements**
- **Visual guidance and decorative day-night effect through luminous module body**
- **Excellent visibility and uniform illumination thanks to premium lighting technology**
- **Streamlined handling, increased durability and comprehensive control functions directly on board with patented iQ luminaire electronics**
- **Additional efficiency boost with the help of patented silver coating (up to 12 percent)**
- **Available with especially insect-friendly, amber-colored lighting (2,200 K)**
- **Flexible control options thanks to future-proof variations with smart interface in accordance with Zhaga standard**

Our classics.

City-Light Pillar 120 (height: 1.2 m), 260 (height: 2.6 m), 400 (height: 4.0 m)



Mushroom luminaire



Litepole 2



Litepole



Lantern Classic



Urban luminaires with Module 540.



Lantern Deluxe

City-Light Elegance

City-Light Plus

Lantern



Innovation modularly packaged and configurable to order.

The latest generation of the Module 540 unites all the advantages of innovative SITECO lighting technology within a simple module concept:

- Individual, digitally controllable light using iQ luminaire electronics
- Low energy consumption thanks to top-of-the-line LEDs and light control with silver coating
- Reliable operation through high-quality materials and manufacturing
- Excellent visibility with precise, glare-free light distribution

That's robust technology that looks damn good. And it's how lighting can create an atmosphere enveloping people in comfort.

Specifications

Net luminous flux	500 ... 5,000 lm
Luminous efficacy of luminaire	up to 160 lm/W
Color rendering	CRI 70 (CRI 80 on request)
Service life	up to 100,000 hours (L95/B10)
Type of protection	IP65
Protection rating	II
Control	Overheating protection power reduction digital communication interface time-dependent luminous flux control flexible luminous flux parameterization optimized constant luminous flux control

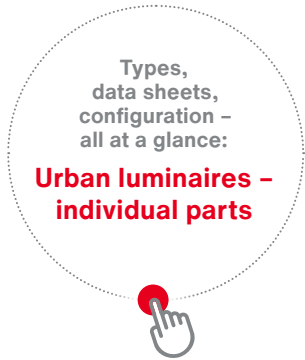

Accessories and spare parts

1 Spreader element

- Additional cover for even greater uniformity in light distribution
- Further increases visibility for pedestrians and drivers, protects against direct viewing of the LED unit and enhances the module's look
- Can be attached without tools
- The amber spreader allows for subsequent adjustment of light colors to, e.g., meet local requirements for nature conservation and insect protection

2 Silver-colored decorative ring

- Cover for the base of the LED Module 540
- Color-coordinated with the body of SITECO urban and park luminaires
- Can be inserted without tools during luminaire installation

3 House-side shielding

- To further reduce the rear lighting component
- Can be mounted in only a few minutes during luminaire installation

4 Module body

- Visual guidance through light reflection
- Made of die cast aluminum

5 LED unit

- Three-zone faceted reflector enables harmonious contrast transitions to make seeing easier

6 Gear tray

- Module body is mounted on the gear tray using a bayonet



Product features for designing with SITECO urban and park luminaires

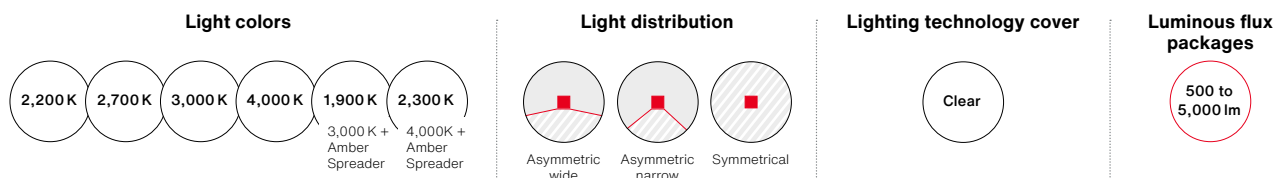

The following spare parts are available individually:

All housing components, diffusers, LED units, control units and gear trays

You can receive the following preset configurations on request:

Color variations (module, housing) | Light color | Light distribution | Lumen packages | Cover | Cables (type, length) | Parameterization (time, dimming level) | iQ settings

SITECO urban and park luminaires ...

... invite.

People like being in places where it is pleasant. Our design classics create atmosphere and ensure people feel good, even in the latest generation.

... highlight.

Decorative solutions style outdoor spaces day and night. They shine and illuminate – for example with coordinated light colors as well, depending on where they are used.

More than light.

Solutions like the urban luminaires with Module 540 don't just illuminate the city – they're part of the city. Their classic forms have enhanced the cityscape day and night sometimes for decades. And now urban residents won't have to do without this emblematic, cherished appearance for their city in the future either. Because no matter how modern, digital, efficient and environmentally friendly the inside of a luminaire is, the atmosphere and distinctive character of the city remains.

My city. My light. SITECO solutions for urban spaces.

**... link
and structure.**

Historical downtowns, city centers, selected squares – they're the ideal home for decorative classics. SITECO's urban lighting solutions help you create a consistent cityscape.

**... act as a
design feature.**

Classic shapes combined with digital light. Our urban luminaires will continue to create aesthetic accents in the cityscape well into the future as well.

**... provide
orientation.**

Decorative solutions do not take a back seat at night. They clearly indicate what directions streets and roads take and function as reference points.

Light: intelligent. Control: intuitive. **Future: on board.**

Comprehensive control and diagnostic options?
Or rather interfaces for sensor technology and the like?

Both, of course!

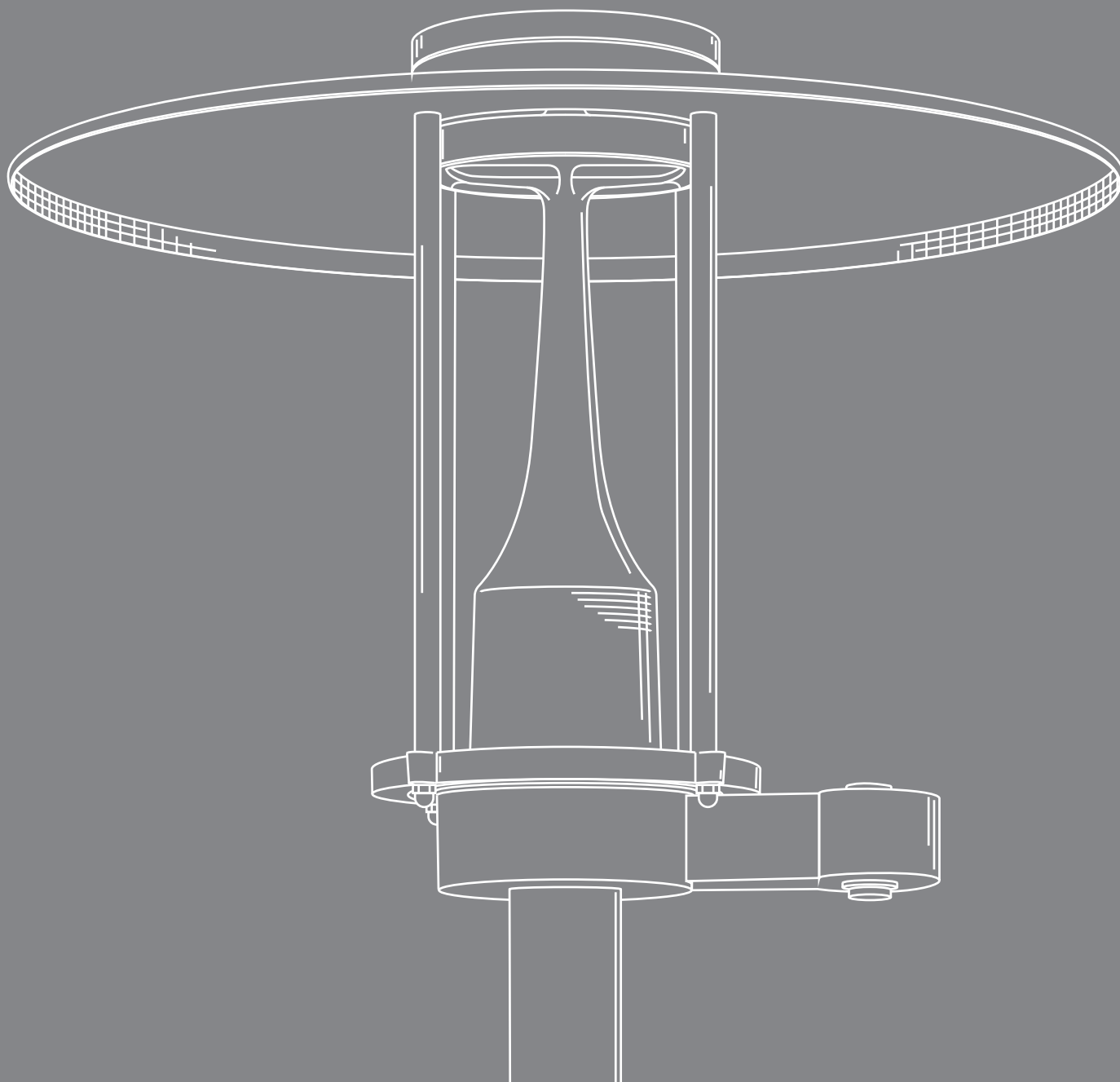

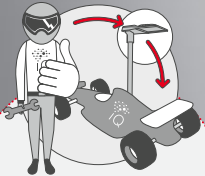

Auto-Match

Exchange ECGs in no time – without reprogramming.

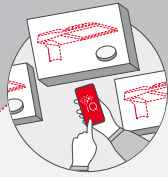

Desk-Remote

Adjust the LED Module 540 in the workshop without power and without opening the box.



Street-Remote

Configure luminaires from the sidewalk or from a vehicle “on the fly.”

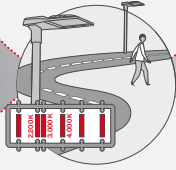

Colour-Switch

Get prepared now for future environmental and animal-protection guidelines and be able to react flexibly.

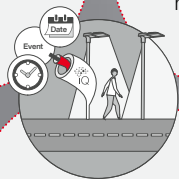

Smart-Wire

Dim inexpensively using existing control wires and intelligently switch between dim profiles, light colors and light distributions.

Smart-Interface is your ticket to entering the world of sensor technology and wireless control.

Smart-Interface complies with the Zhaga D4i standard. So you can be sure our wireless accessories and sensors are 100 % compatible.

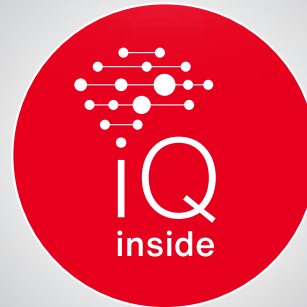

Our **iQ luminaire electronics** link all the parts of the luminaire into a single network – ECG, LED module and optics, transforming individual components into a complete system that you can even configure wirelessly.

You can find out more about iQ here:



SITECO iQ

Because we know what challenges you are facing every day.

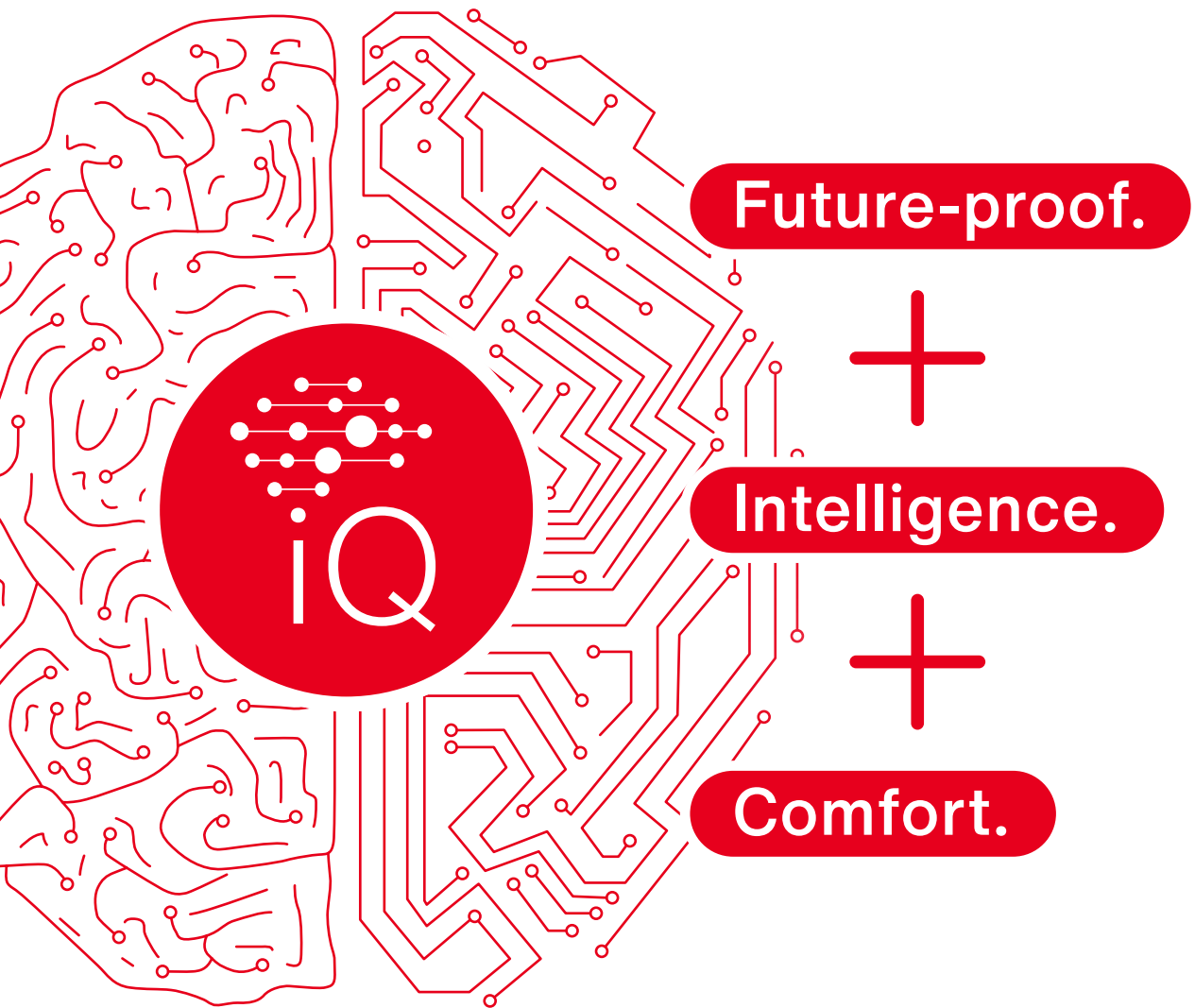
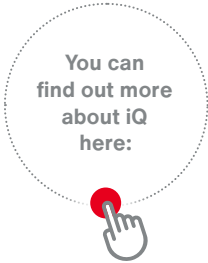

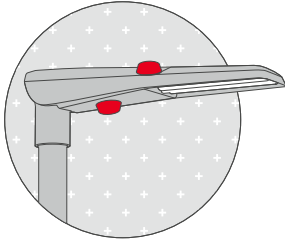

Smart-Interface

Intelligent light at its peak – for maximum future viability.

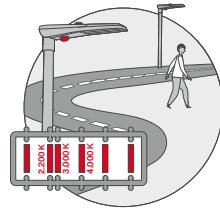

i All Module 540 luminaires are delivered with the innovative Street Remote function package as standard.

Street-Remote

Colour-Switch

Intelligent additional features – for maximum flexibility.

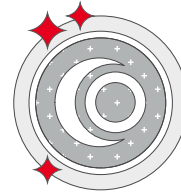
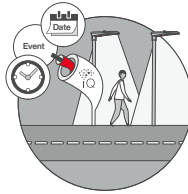
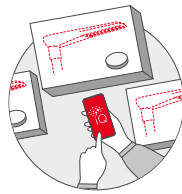
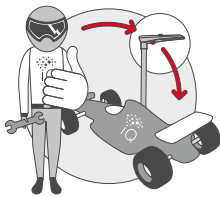

Auto-Match

Desk-Remote

Smart-Wire

Night-Set

iQ App & Webtool

Intelligent features – for maximum convenience in everyday use.

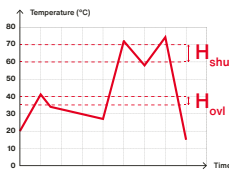
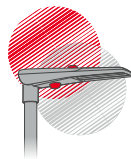
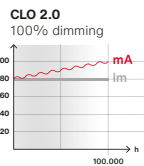

Lumen-Switch

CLO 2.0

Light-Fading

Temp-Guard

Surge Protection

Fuse-Plus

Intelligent foundation – for maximum efficiency.

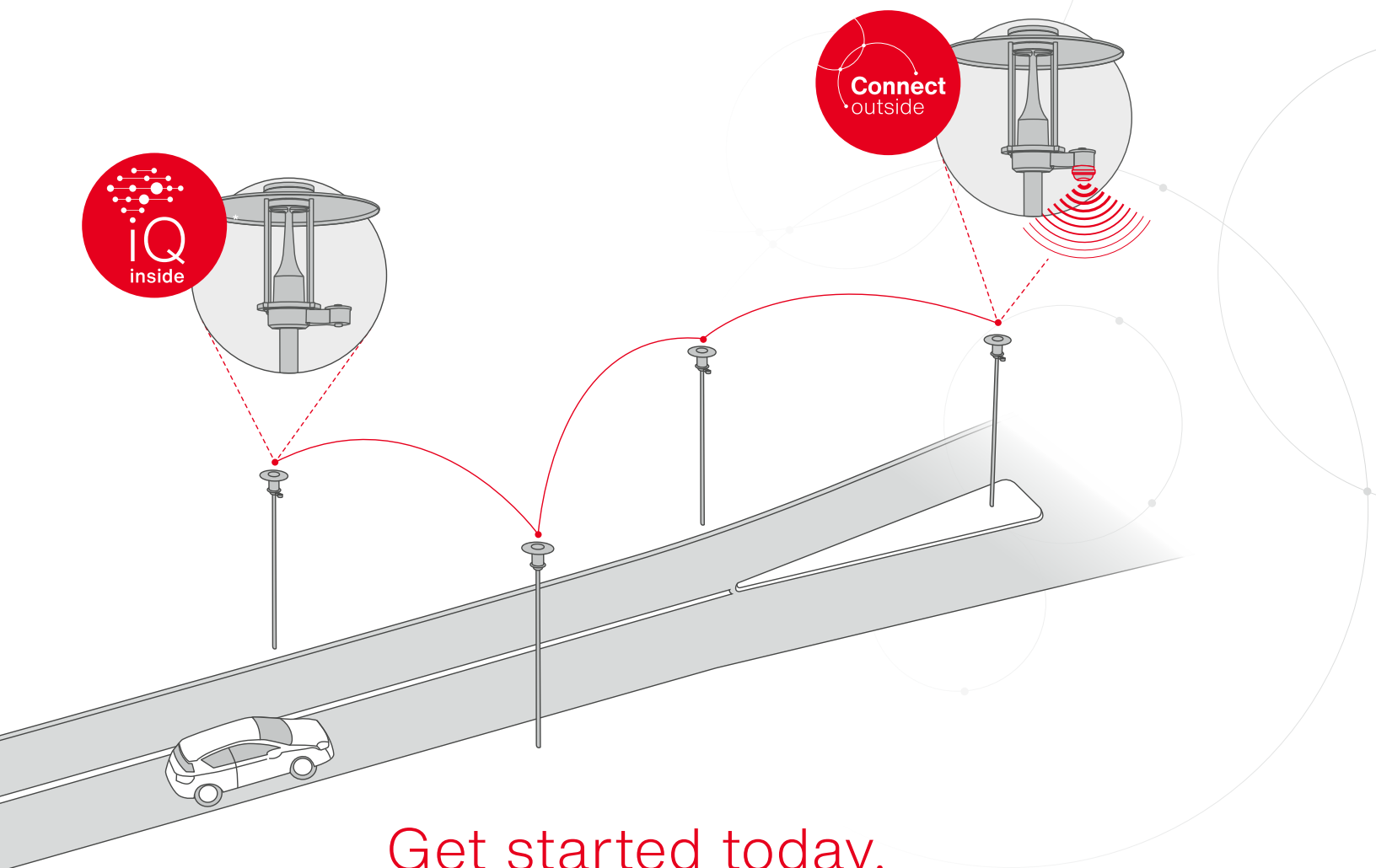

Get started today. With SITECO Connect.

From simple control to a connected system.

There is a good reason why people refer to “city lights” when describing the special attraction of urban spaces. SITECO solutions makes cities and communities even more livable. Thanks to efficient, connected and sustainable lighting solutions.

Thanks to Smart Interface, urban lantern luminaires with Module 540 obtain standardized interfaces based on Zhaga Book 18, D4i and NEMA that enable plug & play mounting of many compatible radio-based control systems and sensors.

The Smart Interface not only ensures a secure future, it also enables additional flexibility and greater independence. Cities and municipalities can adopt the control technology gradually – the time of launching or retrofitting can be selected as required.

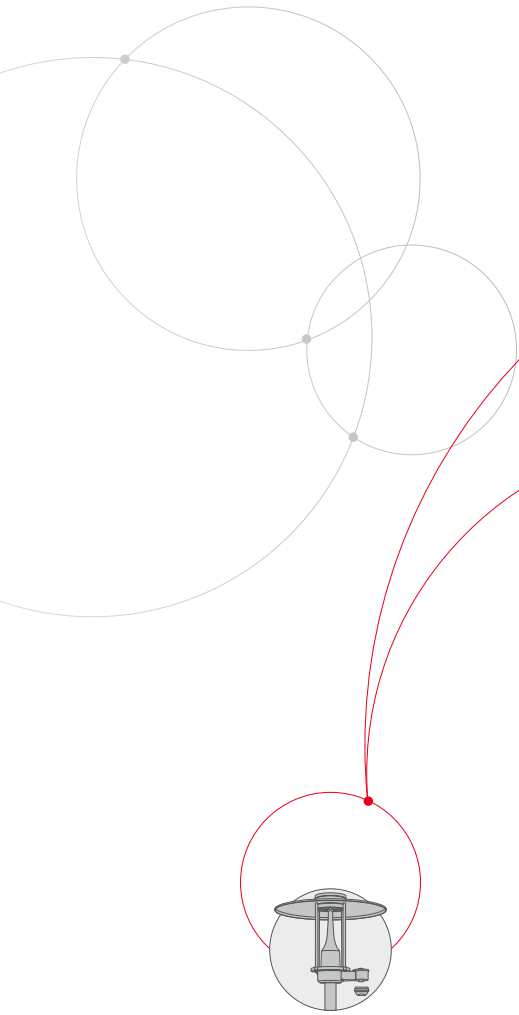

SITECO Connect 31:
Single luminaire

- Individual luminaires are activated or dimmed with a local motion detector.

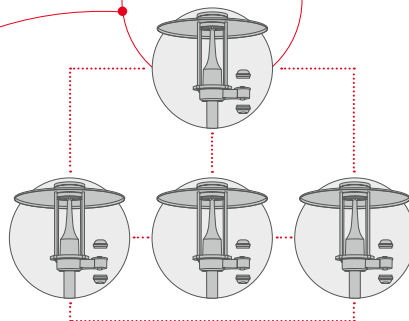

Configure and diagnose on site with a USB transmitter on a laptop

SITECO Connect 21:
Several luminaires connected locally

- Several luminaires are connected via radio.
- The luminaires in the network communicate and synchronize among themselves.
- The luminaires are synchronously or continuously activated or dimmed.

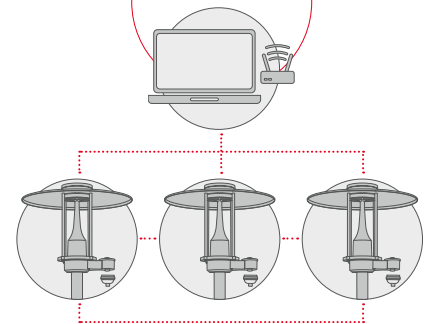

Configure and diagnose using web remote access

SITECO Connect 11:
Several luminaires connected with remote access

- The luminaires are connected via radio.
- Settings can be defined from the office via the network, with access and status messages sent automatically.
- Existing inventory and workflow systems like luxData by sixData can be used as a master.

Advantages with modern lighting control



Improved safety for people on roads and protection from vandalism



Sustainability through the protection of environmental resources and the animal world



Energy efficiency improvements through dimming according to requirements

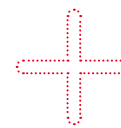

Optimized operational management using current diagnostic data and documented systems

Trend-setting light. Maximum convenience in operational management.

The future means not only intelligent luminaires and control systems, but smart operational management as well. Forget about stacks of paper and manual processes. How about managing everything centrally instead? Manage, control, maintain and service. Using a single interface.

Let's get started today. And work together to define the light and management of the future for your towns and cities.

luxData.easy can ...

... be filled as easily as Excel.

... record all data from the date of installation to energy consumption.

... control all objects in towns and cities.

... monitor lighting and record fault reports.

... measure energy consumption.

... provide custom dashboards for maximum transparency.



SITECO and luxData. Maximum compatibility.

SITECO luminaires can be easily scanned and transmitted.

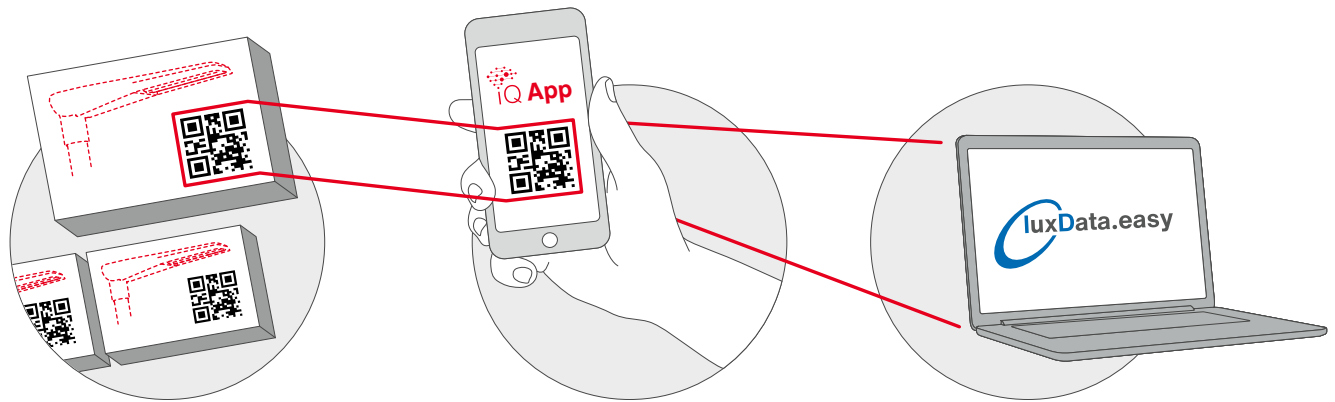

The QR code for inventorying your luminaire is enclosed in the luminaire packaging.

SITECO luminaires can be inventoried using a QR code and transmitted to luxData.easy. The luminaire data can thus be supplemented with important information such as location, time of installation and type of installation.

Point objects

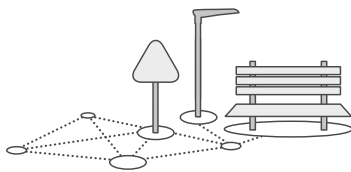

For example: street lighting, traffic lights and illumination of buildings

Surface objects



For example: WiFi coverage, parking lots and playgrounds

Line objects

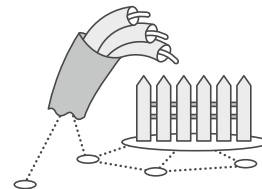

For example: cables and wires



SITECO offers:

**Up to < 1%
light emissions**

As little light as possible in the upper atmosphere is our goal. By cleverly adjusting the module and covers, Module 540 variations make it possible to reduce light emissions to < 1%. For a truly **dark night sky**.

SITECO offers:

**Targeted
lighting
control**

Factory settings with iQ functions can be reset at any time over Bluetooth in front of the mast (without having to use a cherry picker). Complete flexibility thanks to needs-based dimming, switching and control. The reduced level of light has a positive effect on the **natural behavior of animals**.

SITECO offers:

**Insect-
friendly
light**

Amber-colored, 2,200 Kelvin (amber spreader can be mounted at a later point) dramatically **reduces the attraction of** insects. An additional advantage: The luminaires get less dirty as a result. Good for you, good for biodiversity.

SITECO offers:

Simple repairs

Modules, drivers and other components can be replaced easily, sometimes even without tools – the ideal way to make repairs or add updates in no time at all.

SITECO is sustainable light.

SITECO offers:

Environmentally friendly production and packaging

SITECO follows **environmental protection guidelines** for its production operations in Germany. That means: No long transport routes that stretch halfway around the globe and packaging that uses **as little plastic as possible.**

From die-cast aluminum housings to the latest generations of LEDs with special lighting technology we developed – everything about SITECO is designed with **long-lasting operation and significant CO₂ savings** in mind.

SITECO offers:

Sustainable light

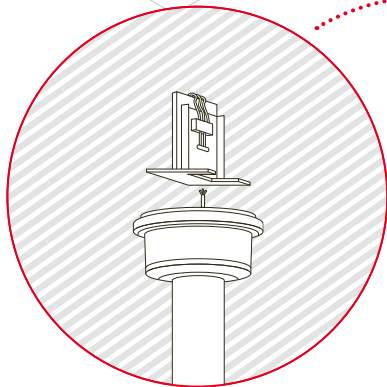

Insert gear tray and connect.

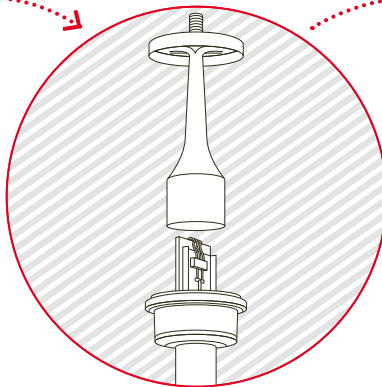

Place the module body on top.

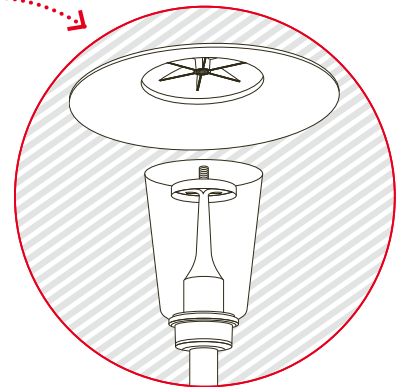

Mount the cover.

Honest environmental protection. Light from thinking green.

Is a product sustainable because it uses less energy? No, production and disposal also have to be included in the calculation. That's why we manufacture our SITECO outdoor luminaires in Germany following energy-optimized manufacturing practices that employ a sophisticated modular concept with exceptionally high recycling rates and the environment in mind. For us, this all means *Made in Germany.*

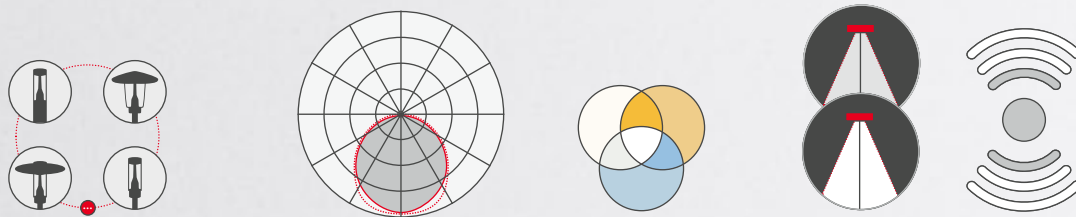
**Luminaire variants:**

- Mast luminaires
- Classic
- bollard luminaires / light pillars

Light distributions:

- ST1.2a
- ST0.5a
- PL1.2S

Light colors:

- 2,200 K
- 2,700 K
- 3,000 K, CRI 70
- 3,000 K, CRI 80
- 4,000 K

Variants:

- Standard
- Power

Control:

- iQ Street-Remote
- no Servicebox
- Servicebox ready (with DALI 2)
 - iQ Smart-Wire (2 steps)
 - iQ Smart-Wire (10 steps)
 - iQ Night-Set
 - iQ Lumen-Switch
- Smart-Interface (no red. wire)
- Smart-Interface (with red. wire)
 - Smart-Interface 1 × (TOP)
 - Smart-Interface 1 × (BOTTOM)
 - Smart-Interface (TOP / BOTTOM)
- Smart-Interface inkl. iQ

Please note: Not all of the features listed above can be combined together to create an effective system. Certain combinations are mutually exclusive. We'd be happy to advise you about your selections.

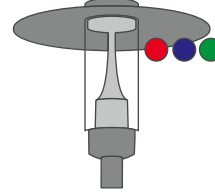
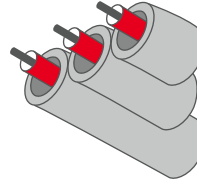
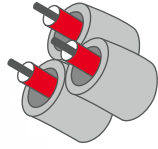

Individual settings:

- Set individual reduction times for the night

Types of cable:

- H07RN-F 3 × 1.5
- H07RN-F 5 × 1.5
- NYM-J 3 × 1.5
- NYM-J 5 × 1.5
- NYM-O 5 × 1.5
- SITECO Plus 5-wire

Cable length:

- 6.5 m

Housing color:

- DB702S
- DB703
- RAL 9005
- RAL 6009
- RAL 5013
- RAL 3005

Module color:

- RAL 9016
- DB702S
- DB703
- RAL 9005
- RAL 6009
- RAL 5013
- RAL 3005

Make it **your light.**

With a wide range of standard models and additional configuration options, urban luminaires with module 540 iQ are always the luminaires you want them to be. With various light colors, optics and mounting options. And always as flexible to control as you want – pre-set and ready for the future.

Aesthetics or efficiency? **Both!**

Saving energy and CO₂ while also designing attractive living spaces for residents: These are the major issues facing cities and communities into the future. In its choice of luminaires, the city of Weil am Rhein relies on true classics that feature innovative, highly efficient inner components.

An outcome that is both visually and numerically compelling: The city now saves 50 percent on energy annually.

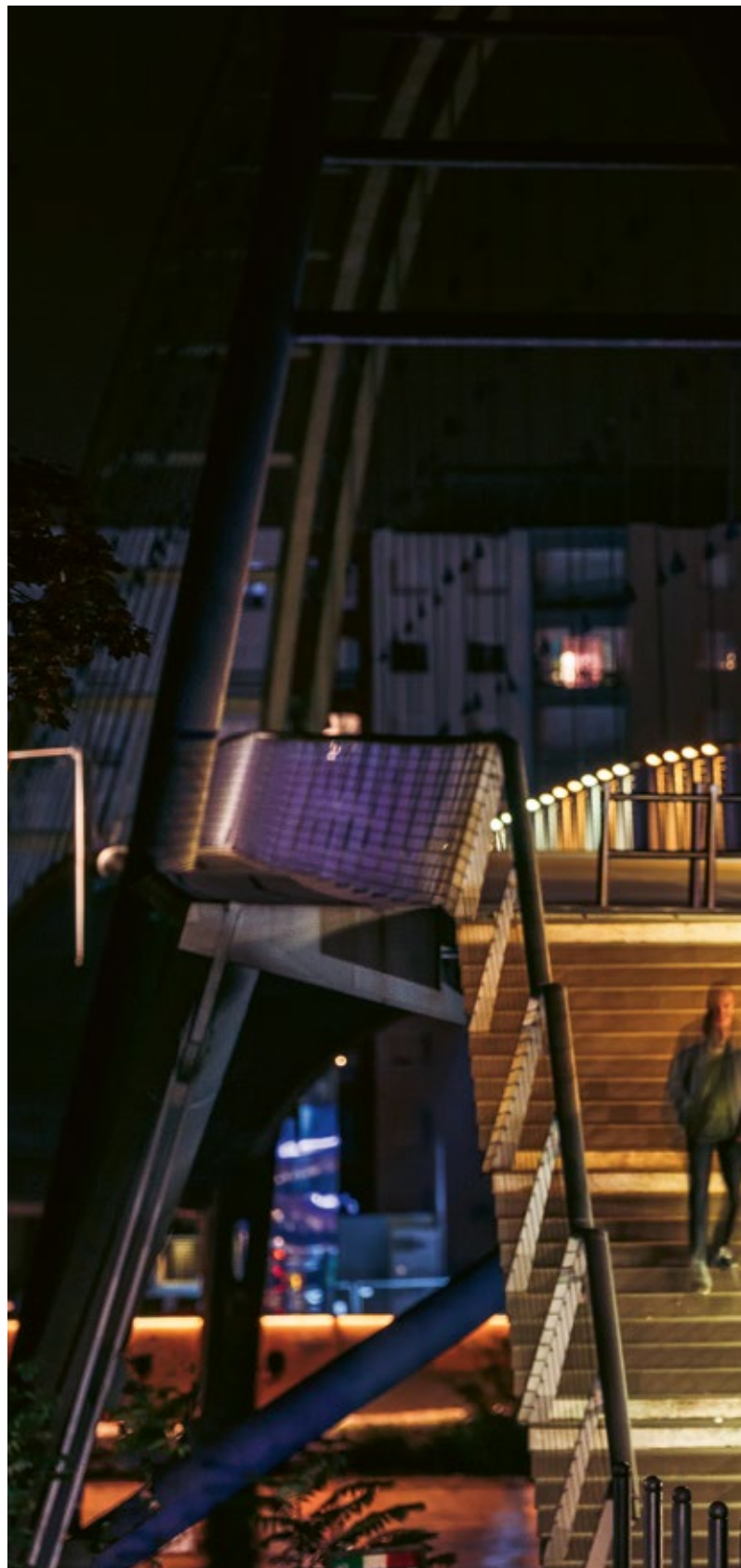



Project: Weil am Rhein

Product: Mushroom with Module 540

Saving energy is teamwork.

How much work may we take off your hands?

+ Light audit

Our experts will analyze your existing set up and define the individual requirements for your new system with you on site. + Reduction of operating costs and CO₂ + Investment and payback

+ Planning

Tailored exactly to your needs, we develop a lighting concept or a customized solution – so that you can benefit from outstanding and sustainable lighting and control technology. + Lighting design + Lighting and electrical concept + Customized solution

+ Project management

Everything from a single source – you have exactly one point of contact: your project manager. They handle the formalities and coordinate all steps – so that everything happens just in time, and everyone is well-integrated. + Project coordination and control

+ Financing

With our individual financing solutions, you save money from day one. The term is flexible and depends entirely on your needs. In addition, we prepare the efficiency proof of at least 50 % CO₂ savings for the funding application. + Government funding consultation + Financing

+ Service

You decide whether we handle the installation through our network of installation partners. If desired, we can also fully operate your system. + Installation and commissioning + Maintenance and servicing

+ Control center

From digital management to maintenance and servicing to control and optimization: the SITECO control center monitors in real time. Thus, we have everything covered for you and coordinate all tasks. + Remote monitoring from the SITECO control center + Troubleshooting + Monitoring of energy savings + Operations management

Choose and combine these six service modules entirely according to your needs.

All tailored to your preferred level of service.

Contact.

Siteco GmbH

Georg-Simon-Ohm-Str. 50
83301 Traunreut, Germany
Tel. +49 8669 330
info@siteco.com

siteco.com