

Order No.: 5XE5E37N08DB | GTIN (EAN): 4058352897133

Product description: SL21mc,STW1.0a,5110lm730,NEMA7



Streetlight SL 21 micro, mast luminaire, primary light control with lens, of PMMA, primary optical cover: cover, of toughened safety glass, transparent, light distribution: STW1.0a, light emission: direct distribution, primary light characteristic: asymmetric, installation type: post-top, LED, 3G 1.5mm², High Power LED, rated luminous flux: 5.110lm, luminous efficacy: 131lm/W, light colour: 730, colour temperature: 3000K, control: overheat protection, pre-setting: linear dimming characteristic, constant luminous flux control, time-dependent luminous flux control, flexible luminous flux parameterisation, mains connection: 230..240V, AC, 50/60Hz, connection cable pre-assembled, cable length: 6,5m, wiring characteristics: H07RN-F, start of lifetime: 39W, end of service life: 41W, reduction: 18W, luminaire housing, of diecast aluminium (EN AC-44300), powder-coated, Siteco® metallic grey (DB 702S), corrosivity category C5 mid according to DIN EN ISO 12944, multi-level sealing system, sealing non-destructively replaceable, inclination adjustable: 0°, 5°, 10°, 15°, length: 528mm, width: 235mm, height: 110mm, spigot size: 76/60mm (post-top), protection rating (complete): IP66, insulation class (complete): insulation class I (protective earthing), certification: CE, ENEC, ENEC+, VDE, impact resistance: IK09, permissible operating ambient temperature for outdoor applications: -40..+50°C, standard-compliant lighting for roads and squares, packaging unit: 1 piece



Lamps:	LED
Wt. (kg):	5.9
GTIN (EAN):	4058352897133



Order No.: 5XE5E37N08DB | GTIN (EAN): 4058352897133

Detailed technical description: SL21mc,STW1.0a,5110lm730,NEMA7



Key data

- Product type: mast luminaire
- Product name: Streetlight SL 21 micro
- Order No.: 5XE5E37N08DB

Lighting technology | Lamps | Control gear

Component 1

Lighting technology:

- Light control: lens of PMMA
- Cover: cover, transparent
- Light distribution: STW1.0a
- Beam angle: wide distribution
- Symmetry: asymmetric distribution
- Light emission: direct distribution

Lamps:

- Lamps: with High Power LED, LED
- Rated luminous flux: 5110lm
- Luminous efficacy: 131lm/W
- Colour temperature: 3000K
- Colour rendering index: CRI > 70
- Light colour: 730
- Rated input power begin service life: 39
- Rated input power end service life: 41
- Rated input power at 50% lumin. flux: 18

Operating device:

- Control: NEMA (7pin)
- Equipment: overheat protection, constant luminous flux control, time-dependent luminous flux control, flexible luminous flux parameterisation, pre-setting: linear dimming characteristic

Certificates, Standards

- Protection rating: IP66
- Insulation class: insulation class I (protective earthing)
- Impact resistance: IK09
- Temperature range (operation): -40..+50°C
- Supplement: standard-compliant lighting for roads and squares
- Corrosion protection: corrosivity category C5 mid according to DIN EN ISO 12944
- Certification, designation: CE, ENEC, ENEC+, VDE

Material, Colour

- luminaire housing: diecast aluminium (EN AC-44300), powder-coated, Siteco® metallic grey (DB 702S), inclination adjustable: 0°, 5°, 10°, 15°, sealing non-destructively replaceable, multi-level sealing system
- Colour specification: Siteco® metallic grey (DB 702S)
- Cover: cover of toughened safety glass

Mounting

- Mounting method, mounting location: post-top, on mast
- Supplement: with pre-assembled mast flange

Electrical connection

- Nominal voltage: 230..240V, 50/60Hz, AC
- Surge voltage resistance: 10kV 1.2/50µs
- Connection cable: pre-assembled, L= 6.5m

Dimensions, Weight

- Length: 528mm
- Width: 235mm
- Height: 110mm
- Weight: 5.9kg
- Mast spigot: spigot size: 76/60mm (post-top)

Light emission

- Light emission: 0% at 0° inclination

Service life

- Rated service life: 100000h (L97/B10) at AT = 25°C

Order No.: 5XE5E37N08DB | GTIN (EAN): 4058352897133

Dimensions: SL21mc,STW1.0a,5110lm730,NEMA7

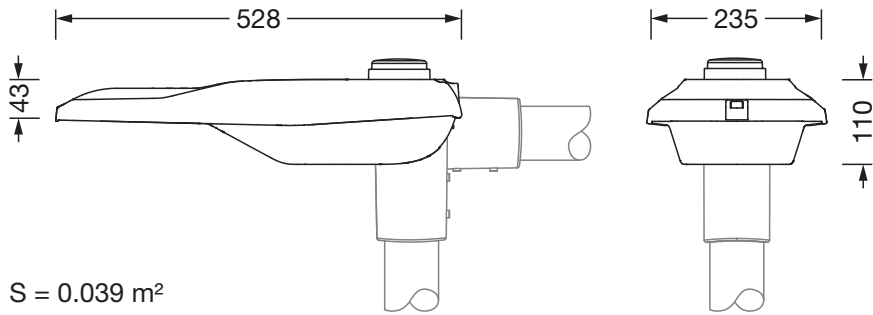

It is mandatory that the assembly instructions must be observed when planning and installing the electrical installation (to be found at www.siteco.com)
Tolerances related to thermal, electrical and photometric data according to IEC 62722
Issued 15.06.2024 - Modifications and errors subject to change - Ensure that you always use the latest version -