

Order No.: 5XE1D43T08DB | GTIN (EAN): 4058352806067

Product description: SL21mc,ST1.0a,5320lm740,D4i,SlA/b



Streetlight SL 21 micro, mast luminaire, primary light control with lens, of PMMA, primary optical cover: cover, of toughened safety glass, transparent, light distribution: ST1.0a, light emission: direct distribution, primary light characteristic: asymmetric, installation type: side-entry, post-top, LED, High Power LED, rated luminous flux: 5.320lm, luminous efficacy: 136lm/W, light colour: 740, colour temperature: 4000K, control: flexible luminous flux parameterisation, time-dependent luminous flux control, constant luminous flux control, overheat protection, pre-setting: logarithmic dimming characteristic, mains connection: 220..240V, AC, 50/60Hz, start of lifetime: 39W, end of service life: 41W, reduction: 18W, luminaire housing, of diecast aluminium, powder-coated, Siteco® metallic grey (DB 702S), corrosivity category C5 mid according to DIN EN ISO 12944, please order mast flange separately, inclination adjustable: 0°, 5°, 10°, 15°, sealing non-destructively replaceable, multi-level sealing system, length: 528mm, width: 235mm, height: 110mm, mast flange for spigot size: 42mm (side-entry): 5XC10008XM4, 60/48mm (side-entry/post-top): 5XC10108XM2, 76/60mm (side-entry/post-top): 5XC10108XM1, Smart Interface below and above, protection rating (complete): IP66, insulation class (complete): insulation class II (safety insulation), certification: CE, ENEC, ENEC+, VDE, impact resistance: IK09, permissible operating ambient temperature for outdoor applications: -40..+50°C, standard-compliant lighting for roads and squares, packaging unit: 1 piece



Lamps: LED
 Wt. (kg): 4.5
 GTIN (EAN): 4058352806067



Order No.: 5XE1D43T08DB | **GTIN (EAN):** 4058352806067

Detailed technical description: SL21mc,ST1.0a,5320lm740,D4i,Sla/b



Key data

- Product type: mast luminaire
- Product name: Streetlight SL 21 micro
- Order No.: 5XE1D43T08DB

Lighting technology | Lamps | Control gear

Component 1

Lighting technology:

- Light control: lens of PMMA
- Cover: cover, transparent
- Light distribution: ST1.0a
- Beam angle: wide distribution
- Symmetry: asymmetric distribution
- Light emission: direct distribution

Lamps:

- Lamps: with High Power LED, LED
- Rated luminous flux: 5320lm
- Luminous efficacy: 136lm/W
- Colour temperature: 4000K
- Colour rendering index: CRI > 70
- Light colour: 740
- Rated input power begin service life: 39
- Rated input power end service life: 41
- Rated input power at 50% lumin. flux: 18

Operating device:

- Control: D4i, Smart Interface below and above
- Equipment: overheat protection, constant luminous flux control, time-dependent luminous flux control, flexible luminous flux parameterisation, pre-setting: logarithmic dimming characteristic

Certificates, Standards

- Protection rating: IP66
- Insulation class: insulation class II (safety insulation)
- Impact resistance: IK09
- Temperature range (operation): -40..+50°C
- Supplement: standard-compliant lighting for roads and squares
- Corrosion protection: corrosivity category C5 mid according to DIN EN ISO 12944
- Certification, designation: CE, ENEC, ENEC+, VDE

Material, Colour

- luminaire housing: diecast aluminium, powder-coated, Siteco® metallic grey (DB 702S), please order mast flange separately, inclination adjustable: 0°, 5°, 10°, 15°, sealing non-destructively replaceable, multi-level sealing system
- Colour specification: Siteco® metallic grey (DB 702S)
- Cover: cover of toughened safety glass

Mounting

- Mounting method, mounting location: side-entry, post-top, on mast

Electrical connection

- Nominal voltage: 220..240V, 50/60Hz, AC
- Surge voltage resistance: 10kV 1.2/50µs

Dimensions, Weight

- Length: 528mm
- Width: 235mm
- Height: 110mm
- Weight: 4.5kg
- Mast spigot: mast flange for spigot size: 42mm (side-entry): 5XC10008XM4, 60/48mm (side-entry/post-top): 5XC10108XM2, 76/60mm (side-entry/post-top): 5XC10108XM1

Light emission

- Light emission: 0% at 0° inclination

Service life

- Rated service life: 100000h (L96/B10) at AT = 25°C

Order No.: 5XE1D43T08DB | GTIN (EAN): 4058352806067

Dimensions: SL21mc,ST1.0a,5320lm740,D4i,SlA/b

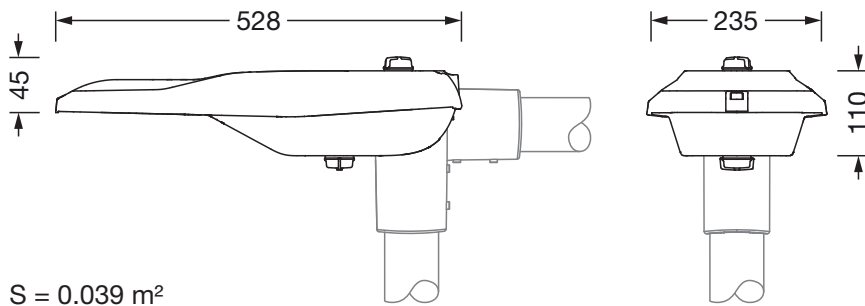

S = 0.039 m²