

Order No.: 59MQ12005021 | **GTIN (EAN):** 4058352465332

Product description: Apollon-,f.lum.M600

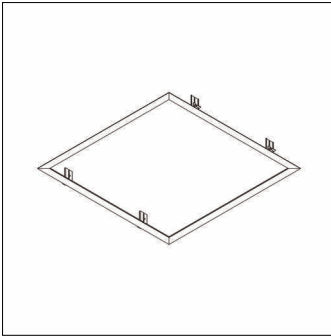

Apollon®, ceiling recessing frame, installation type: recessed, mounting frame, of sheet steel, white, length: 638mm, width: 638mm, packaging unit: 1 piece

Wt. (kg): 0.7
GTIN (EAN): 4058352465332

Order No.: 59MQ12005021 | GTIN (EAN): 4058352465332

Detailed technical description: Apol-,f.lum.M600

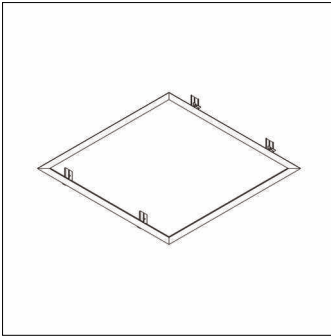

Key data

- Product type: ceiling recessing frame
- Product name: Apollon®
- Order No.: 59MQ12005021

Material, Colour

- mounting frame: sheet steel, white
- Colour specification: white

Mounting

- Mounting method, mounting location: recessed, in the ceiling
- Supplement: for luminaire M600

Dimensions, Weight

- Length: 638mm
- Width: 638mm
- Weight: 0.7kg