

**Order No.:** 5XMOD1115K | **GTIN (EAN):** 4058352690260

**Product description:** SL10mnmd,LEDmod,ST1.2a,740



Streetlight 10 mini/midi, LED module, light distribution: ST1.2a, primary light characteristic: asymmetric, High Power LED, light colour: 740, colour temperature: 4000K, mains connection: 230..240V, 50Hz, LED module, length: 310mm, width: 137mm, height: 40mm, protection rating (complete): as luminaire, packaging unit: 1 piece

Wt. (kg): 1.3  
GTIN (EAN): 4058352690260

Order No.: 5XMOD1115K | GTIN (EAN): 4058352690260

Detailed technical description: SL10mmmd,LEDmod,ST1.2a,740

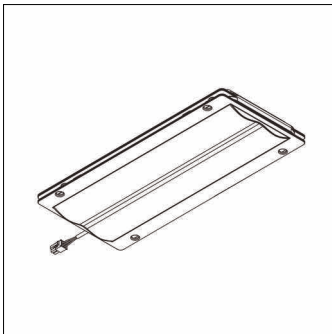

#### Key data

- Product type: LED module
- Product name: Streetlight 10 mini/midi
- Order No.: 5XMOD1115K

#### Lighting technology | Lamps | Control gear

##### Component 1

#### Lighting technology:

- Light distribution: ST1.2a
- Beam angle: wide distribution
- Symmetry: asymmetric distribution

#### Lamps:

- Lamps: with High Power LED
- Colour temperature: 4000K
- Colour rendering index: CRI > 70
- Light colour: 740
- Supplement: power consumption when used in Streetlight 10 Plus luminaires:  
construction size mini 16.2..22.8W,  
construction size midi 45.1..63.6W

#### Certificates, Standards

- Protection rating: as luminaire

#### Electrical connection

- Nominal voltage: 230..240V, 50Hz

#### Dimensions, Weight

- Length: 310mm
- Width: 137mm
- Height: 40mm
- Weight: 1.3kg