

Order No.: 5XE5P47N08CB | GTIN (EAN): 4058352897263

Product description: SL21mc,ST1.5a,2340lm740,NEMA7



Streetlight SL 21 micro, mast luminaire, primary light control with lens, of PMMA, primary optical cover: cover, of toughened safety glass, transparent, light distribution: ST1.5a, light emission: direct distribution, primary light characteristic: asymmetric, installation type: post-top, LED, 3G 1.5mm², High Power LED, rated luminous flux: 2.340lm, luminous efficacy: 148lm/W, light colour: 740, colour temperature: 4000K, control: overheat protection, pre-setting: linear dimming characteristic, constant luminous flux control, time-dependent luminous flux control, flexible luminous flux parameterisation, mains connection: 230..240V, AC, 50/60Hz, connection cable pre-assembled, cable length: 6,5m, wiring characteristics: H07RN-F, start of lifetime: 16W, end of service life: 16W, reduction: 8W, luminaire housing, of diecast aluminium (EN AC-44300), powder-coated, Siteco® metallic grey (DB 702S), corrosivity category C5 mid according to DIN EN ISO 12944, multi-level sealing system, sealing non-destructively replaceable, inclination adjustable: 0°, 5°, 10°, 15°, length: 528mm, width: 235mm, height: 110mm, spigot size: 76/60mm (post-top), protection rating (complete): IP66, insulation class (complete): insulation class I (protective earthing), certification: CE, ENEC, ENEC+, VDE, impact resistance: IK09, permissible operating ambient temperature for outdoor applications: -40..+50°C, standard-compliant lighting for roads and squares, packaging unit: 1 piece



Lamps:	LED
Wt. (kg):	5.9
GTIN (EAN):	4058352897263



Order No.: 5XE5P47N08CB | GTIN (EAN): 4058352897263

Detailed technical description: SL21mc,ST1.5a,2340lm740,NEMA7



Key data

- Product type: mast luminaire
- Product name: Streetlight SL 21 micro
- Order No.: 5XE5P47N08CB

Lighting technology | Lamps | Control gear

Component 1

Lighting technology:

- Light control: lens of PMMA
- Cover: cover, transparent
- Light distribution: ST1.5a
- Beam angle: wide distribution
- Symmetry: asymmetric distribution
- Light emission: direct distribution

Lamps:

- Lamps: with High Power LED, LED
- Rated luminous flux: 2340lm
- Luminous efficacy: 148lm/W
- Colour temperature: 4000K
- Colour rendering index: CRI > 70
- Light colour: 740
- Rated input power begin service life: 16
- Rated input power end service life: 16
- Rated input power at 50% lumin. flux: 8

Operating device:

- Control: NEMA (7pin)
- Equipment: overheat protection, constant luminous flux control, time-dependent luminous flux control, flexible luminous flux parameterisation, pre-setting: linear dimming characteristic

Certificates, Standards

- Protection rating: IP66
- Insulation class: insulation class I (protective earthing)
- Impact resistance: IK09
- Temperature range (operation): -40..+50°C
- Supplement: standard-compliant lighting for roads and squares
- Corrosion protection: corrosivity category C5 mid according to DIN EN ISO 12944
- Certification, designation: CE, ENEC, ENEC+, VDE

Material, Colour

- luminaire housing: diecast aluminium (EN AC-44300), powder-coated, Siteco® metallic grey (DB 702S), inclination adjustable: 0°, 5°, 10°, 15°, sealing non-destructively replaceable, multi-level sealing system
- Colour specification: Siteco® metallic grey (DB 702S)
- Cover: cover of toughened safety glass

Mounting

- Mounting method, mounting location: post-top, on mast
- Supplement: with pre-assembled mast flange

Electrical connection

- Nominal voltage: 230..240V, 50/60Hz, AC
- Surge voltage resistance: 10kV 1.2/50µs
- Connection cable: pre-assembled, L= 6.5m

Dimensions, Weight

- Length: 528mm
- Width: 235mm
- Height: 110mm
- Weight: 5.9kg
- Mast spigot: spigot size: 76/60mm (post-top)

Light emission

- Light emission: 0% at 0° inclination

Service life

- Rated service life: 100000h (L97/B10) at AT = 25°C

Order No.: 5XE5P47N08CB | GTIN (EAN): 4058352897263

Dimensions: SL21mc,ST1.5a,2340lm740,NEMA7

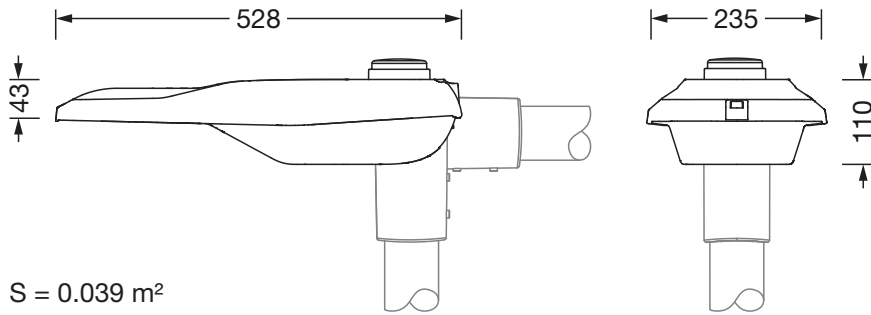

$S = 0.039 \text{ m}^2$