

Order No.: 5XCMOD2C4HC | **GTIN (EAN):** 4058352392089

Product description: SL11,Plusmnm,LEDmod,P1.0a,740



Streetlight SL 11 Plus mini/midi, LED module, primary light control with cycle path optic, light distribution: P1.0a, primary light characteristic: asymmetric, High Power LED, light colour: 740, colour temperature: 4000K, mains connection: 230V, 50Hz, LED module, protection rating (complete): as luminaire, packaging unit: 1 piece

Wt. (kg): 0.6
GTIN (EAN): 4058352392089

Order No.: 5XCMOD2C4HC | GTIN (EAN): 4058352392089

Detailed technical description: SL11,Plusmnmd,LEDmod,P1.0a,740

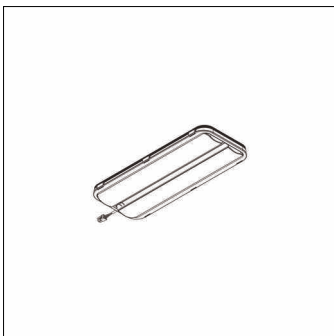

Key data

- Product type: LED module
- Product name: Streetlight SL 11 Plus mini/midi
- Order No.: 5XCMOD2C4HC

Lighting technology | Lamps | Control gear

Component 1

Lighting technology:

- Light control: cycle path optic
- Light distribution: P1.0a
- Beam angle: extremely wide distribution
- Symmetry: asymmetric distribution

Lamps:

- Lamps: with High Power LED
- Colour temperature: 4000K
- Colour rendering index: CRI > 70
- Light colour: 740

Certificates, Standards

- Protection rating: as luminaire

Electrical connection

- Nominal voltage: 230V, 50Hz

Dimensions, Weight

- Weight: 0.6kg