

Order No.: 59MQ18005021 | GTIN (EAN): 4058352465387

Product description: Apollon-,f.lum.1195x295

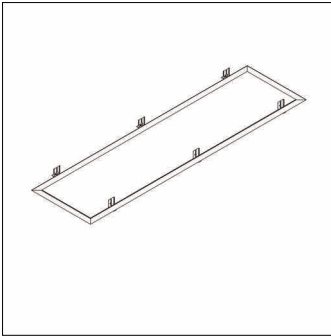

Apollon®, ceiling recessing frame, installation type: recessed, mounting frame, of sheet steel, white, length: 1.239mm, width: 339mm, packaging unit: 1 piece

Wt. (kg): 0.9
GTIN (EAN): 4058352465387

Order No.: 59MQ18005021 | GTIN (EAN): 4058352465387

Detailed technical description: Apol-,f.lum.1195x295

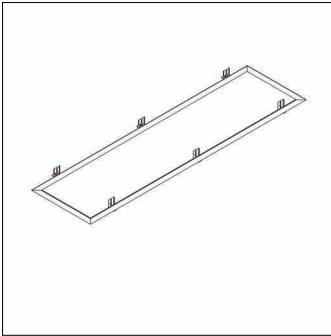

Key data

- Product type: ceiling recessing frame
- Product name: Apollon®
- Order No.: 59MQ18005021

Material, Colour

- mounting frame: sheet steel, white
- Colour specification: white

Mounting

- Mounting method, mounting location: recessed, in the ceiling
- Supplement: for luminaire Lx B= 1195 x 295mm

Dimensions, Weight

- Length: 1239mm
- Width: 339mm
- Weight: 0.9kg