

siteco

Future.



SIT



Light.



We are shaping
the light and
the sustainable
infrastructure
of the future.

150 years of lighting technology made in Germany

1862

Siemens & Halske AG founded (incl. Siemens Beleuchtungstechnik lighting technology)

SIEMENS



1882

First road luminaire in Berlin



1949

Production relocated to Traunreut

1962
100 years of Siemens lighting and first lighting test center

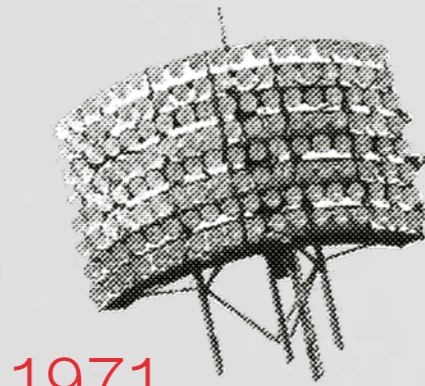

1971

First 3.5 kw floodlights used at the Munich Olympic Games



1975

First trunking system

1980

First BAP50 louver luminaire

1982

First HCL solution using a daylight system

1987

First secondary system as a basis for successful MirrorTec concept

siteco

1997

SITECO founded

1998

Patent for microprismatic technology

2008

First LED road luminaire



siteco OSRAM

2011

SITECO becomes part of OSRAM

2006

First LED office luminaire

2019

Sirius® is the first LED floodlight



2019

SITECO once again becomes an independent, medium-sized company

siteco Stern Stewart Capital

2020

- New burst of products with Licross®, Streetlight SL 21, Monsun® 12 & FL21
- SITECO Connect offers a new level of digital solutions



2021

IoT revolution at SITECO with Flexport

2022

- SITECO HCL^{live} 2.0 as an innovative combination with daylight system
- UWB (ultra wideband) radio technology integrated in the Licross® trunking system

2023

SITECO is established as a leading provider of sustainable infrastructure solutions

We are shaping the light and the sustainable infrastructure of the future.

Light is so incredibly important. 80 % of our perception is visual. Light helps to regulate our inner clock.
Light gives us energy.
Light gives us safety.

The sun is perfect. But we have stopped following its rules.

We work in closed quarters and turn the night into day. Light is something we take for granted, yet it is so demanding. All light is not created equal.

SITECO stands for the future of light.



Industry

From **efficient** lighting solutions to the flexible backbone of building technology

Retail sector

Beyond Lighting and perfect light for staging an **unforgettable** shopping experience

Sports & events

Best lighting quality for broadcasting **magical** moments throughout the world

Office

Be inside and feel outside thanks to **innovative** lighting solutions

Airports & Open spaces

State-of-the-art lighting systems as a guarantee for **safe** and trouble-free operation

City

Sustainable investments for the future of cities and communities

Tunnels

Outstanding lighting technology for arteries with **sustainable** traffic infrastructures



What awaits us tomorrow – how we live, work and produce – is unpredictable. **But we connect the future of light with something you can count on – our promise.**

We have been reliably thinking ahead for more than 150 years.

Together with lighting designers, architects, installers, trade partners and end customers. For cities, industry, retail and infrastructure. But above all for those who experience it daily – for people.

Future

We are contributing to the future of our customers.
With sustainability, flexibility and quality of life.
SITECO stands for outstanding lighting technology
and lighting solutions – designed and engineered
in Germany.



Sustainability

Flexibility
Quality of life

Being truly green
requires action,
not words.

Strict cost management is now part of everyday life for business and communities. Efficiency is directly related to long-term future viability. What's more, social responsibility for the sustainable use of our resources is greater than ever. Reducing CO₂ is a task that spans generations. Forward-looking lighting technology enables a dramatic reduction in energy consumption, CO₂ emissions and operating overheads.

**SITECO stands for sustainable
lighting technology.**



Sustainability

Flexibility

Quality of life

Be flexible, and
you can look to
the future with
confidence.

One thing is certain: The future is digital. So we can no longer look at light in isolation. It is part of a connected infrastructure, integrated in intelligent systems and combined with other systems – a real added value of digitization. But these diverse technological options present considerable investment risks. That makes it all the more important for the entire infrastructure to be highly flexible and intelligently designed. Maximum adaptability in application and simplest compatibility through open standards provide the basis for this.

SITECO stands for intelligent lighting solutions.



Sustainability
Flexibility

Quality of life

We've forgotten
how to recognize
light as part of
our life energy.

80 % of our perception is visual. Light provides energy and safety. Light enhances and creates atmosphere – at the office, during production or in the city. Yet the true potential of light quality is largely untapped. The emphasis is too often on safety standards or regulations. Proper lighting is what makes the difference and puts the focus on people. For greater well-being, motivation and success.

SITECO stands for the best light.

Applications

Individual solutions let us address the needs of our customers in the application areas of industry, office, retail, city, tunnels, airports & open spaces and sports & events.

It is our conviction: We can no longer look at light in isolation. Today's world requires connected solutions that are integrated into central management and automation systems and designed for the specific requirements of the application at hand.

Future Industry.

Efficiency and adaptability are key factors for long-term success.

Cost discipline is the foundation for sustainable competitiveness. At the same time, companies need to be able to quickly and flexibly react to changing usage and environmental conditions. Forward-looking lighting solutions enable a dramatic reduction in costs and offer maximum flexibility in use.

Maximum system efficiency up to 200 lm/w and innovative technologies such as the CLOi luminous flux tracking system are our guarantee for low operating costs, short pay-back periods and immense CO₂ savings. With 14 open lines, the Licross® trunking system is the backbone of building technology and opens up entirely new potential applications: from simple connection of plug & play sensors, smoke detectors or wifi routers through to integration in various building management systems thanks to open interfaces.

Efficient and future-proof in all dimensions thanks to outstanding lighting technology.

up to **90%** reduced energy consumption thanks to intelligent follow-me control

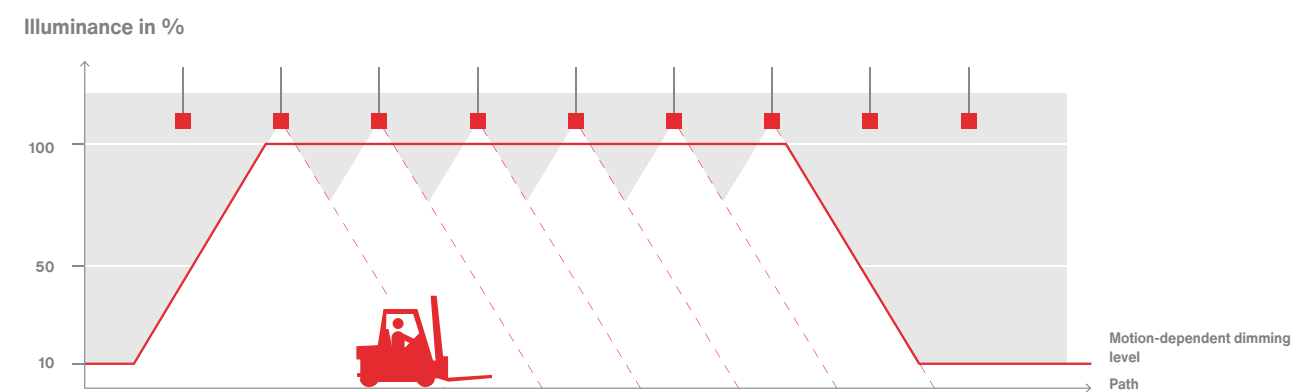

1
Project: Spedition Bork, Langgöns, Germany
Product: Floodlight FL 20

2
Project: Linde Gas, Marl, Germany
Product: Modario® trunking system





1

Project: Beckhoff Automation, Verl, Germany
Product: Modario® trunking system and Beckhoff control

2

Project: Joyn, Munich, Germany
Product: Silica®

2

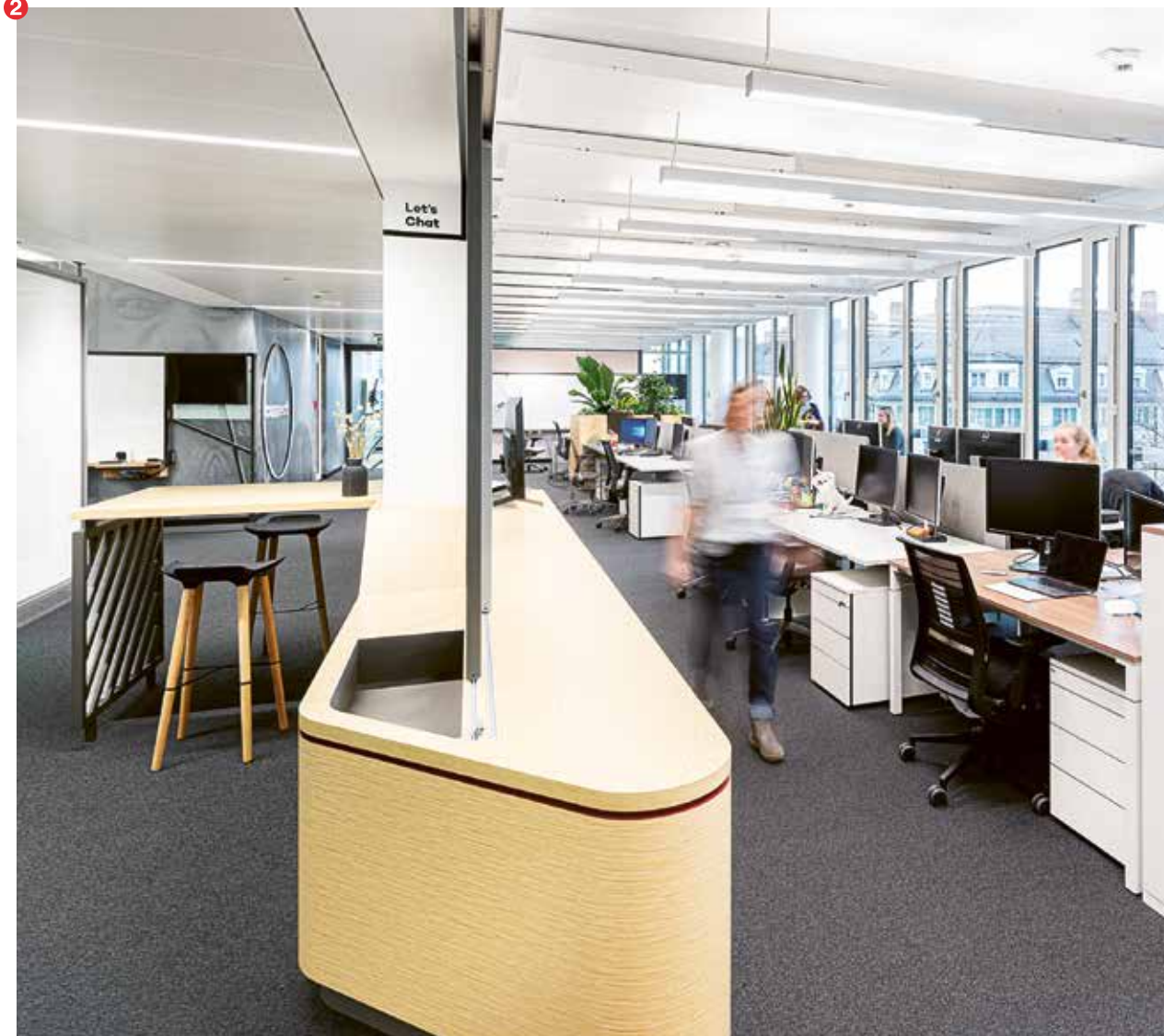

Future Office.

Where work and life come together.

The offices of tomorrow are a dynamic hub for sharing information and knowledge. Contemporary room concepts emphasize people as knowledge carriers and key players. As an elementary component, light enables concentrated work and ensures a pleasant atmosphere.

Technologies such as the patented Micro Lens Array provide homogeneous illumination, maximum glare control and excellent color rendering. Our HCL^{live} concept not only adjusts photometric parameters, it also fine-tunes biological and emotional factors to your individual circumstances. The full effect of light for greater motivation and enhanced well-being.

Lighting technology for greater quality of life – light for people.

HCL^{live}

Dynamic sequence of illuminance and color temperature (example)

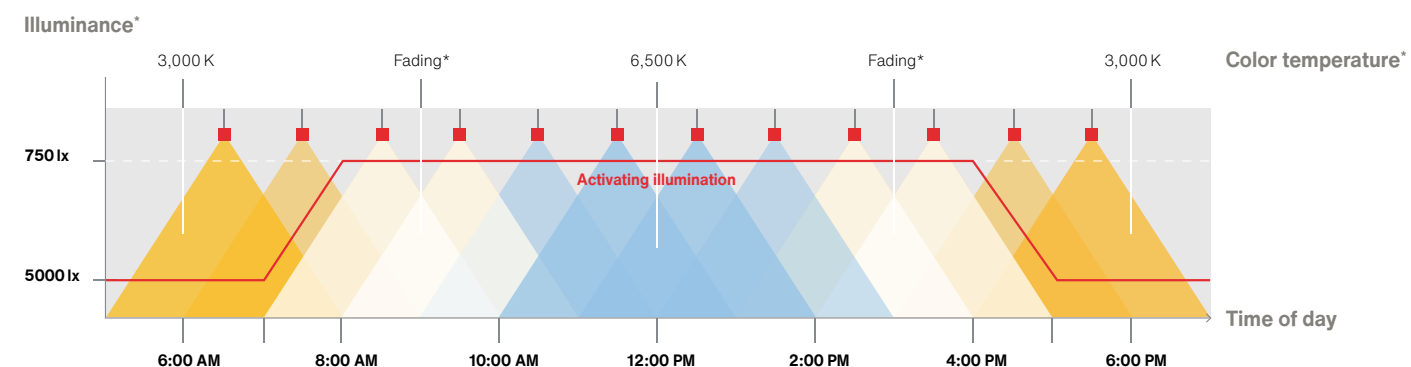

* Project-specific layout according to DIN SPEC 67600, 5031-100 and EN 12464-1

1 Project: Spedition Bork, Langgöns, Germany
Product: Floodlight FL 20

2 Project: ICA Maxi, Jönköping, Sweden
Products: Modario® trunking system, Apollon®, Monsun® 2

3 Project: Audi Madrid, Spain
Product: Project-specific special luminaires



Future Retail.

Intelligent light turns shopping into an event.

There is increasingly fierce competition between brick-and-mortar retailers and the Internet. The selling experience must therefore become a key distinguishing feature. Modern lighting technology gives products an optimal stage and, with a digital infrastructure, provides the basis for customized service.

Innovative optics with silver-coated reflectors and up to 900 lx illuminance ensure that products are perfectly presented.

With up to 14 open cores, Licross® enables integration in intelligent Beyond Lighting solutions such as indoor navigation or customer flow analyses – a new level of potential applications for stores and visitors.

Innovative lighting solutions as a success factor for stores of the future.

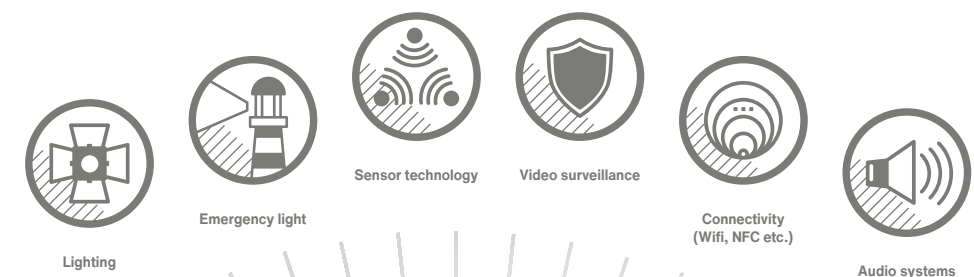

14 cores
for integration in a wide range
of Beyond Lighting components



Future City.

Being truly green requires action, not words.

An incredible 80 % of street lighting in Germany is still conventional. But by switching to efficient LED street lighting, cities and municipalities can play a pioneering role on the path to greater sustainability. At the same time, they can generate real value for citizens – by improving safety on roads, minimizing light pollution and creating an aesthetic cityscape.

High efficiency LEDs and a perfectly balanced design principle with Streetlight SL 11 provide immense energy and CO₂ savings of up to 80 %. CLO 2.0 enables even more precise control for luminous flux and significantly extends the life of the luminaire. Perfectly directed light without unnecessary scattering is always guaranteed with our silver-coated HD faceted reflectors. Open interfaces and intelligent lighting management with SITECO Connect lay the foundation for urban services of the future.

Sustainable investments in the connected city of tomorrow.

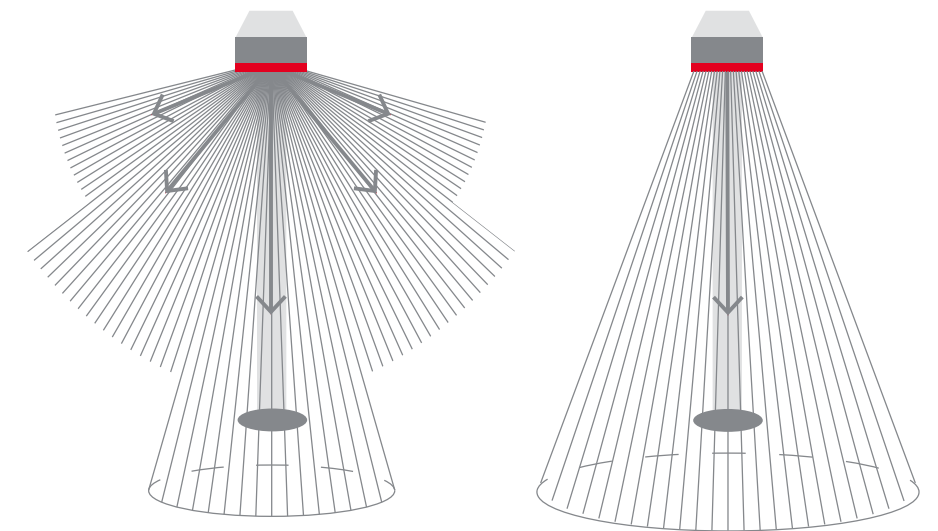

Conventional street lamps produce higher light pollution – and therefore adversely affect the environment, adjacent areas and residents.

Our solutions minimize unnecessary stray light thanks to directed light from innovative optic concepts.



Project: City of Mannheim, Germany
Product: DL® 50 catenary luminaire

Project: Municipality of Balgheim, Germany
Products: Streetlight SL 10, DL® 30,
Floodlight FL 20

100,000 hours

Service life with just 5 % light reduction

100 %

95 %

1

Project: Eyholz Tunnel, Visp, Switzerland
Product: Tunnellight TL 13

2

Project: Pedestrian underpass Freimann, Munich, Germany
Product: Project-specific special luminaire

3

Project: Katzensee Tunnel, Zurich, Switzerland
Product: Tunnellight TL 13, Streetlight SL 20



Future Tunnel.

The arteries of sustainable traffic infrastructures.

Tunnels optimize traffic, unburden roads, reduce noise and decrease levels of fine dust. To do this, they require excellent lighting – day and night. State-of-the-art lighting technology is critical – with maximum efficiency and reliable operation from entrance to exit.

Efficiency values of 185 lm/W and innovative luminous flux control using luminance cameras protect the environment and the operator's balance sheet. Total reliability with a service life of up to 100,000 hours with only a 5 % drop in luminous flux ensures minimal tunnel closures and maximum homogeneous illumination with UI values up to 1 for the greatest possible safety.

Expertise from more than 1,000 tunnel projects worldwide.

3





Project: Bork, Langgöns
Product: Floodlight FL 20

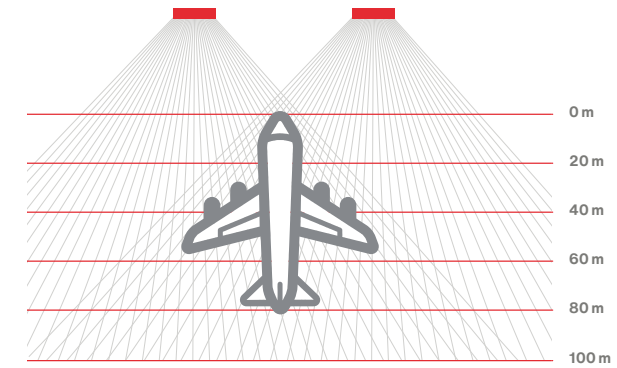

up to **100** meters
Beam depth

Future Airports & Open spaces.

Light for places that never rest.

Airports and logistics facilities work 24/7. To keep the gears of the endless processes turning smoothly, nothing can go wrong. Maximum reliability and the utmost safety are critical for everyone involved.

309,000 lm and 100,000 h service life are our guarantee for powerful, reliable illumination. With a beam depth of more than 100 meters, the Sirius can easily illuminate the parking space of an Airbus A380. Innovative optic concepts such as full cut-off technology ensure that no one is blinded – the basis for optimal working conditions.

Uncompromising reliability and safety thanks to exceptional lighting technology.



Future Sports & Events.

When heroes are born and world-class light has its finest hour.

Up close and personal – experience the thrill of the moment. It’s about the perfect image, that moment for eternity. It requires superior performance. Especially with light: Maximum visual comfort for players and spectators, perfect quality of light to broadcast throughout the world.

With up to 309,000 lm, optimum glare control thanks to full cut-off technology and best-in-class color rendition values of TLCI96, our floodlights ensure optimum visibility – whether on site or in front of the TV. And innovative module control via DMX also makes the ideal La Ola effect possible with technical lighting.

Outstanding lighting technology for the perfect experience.

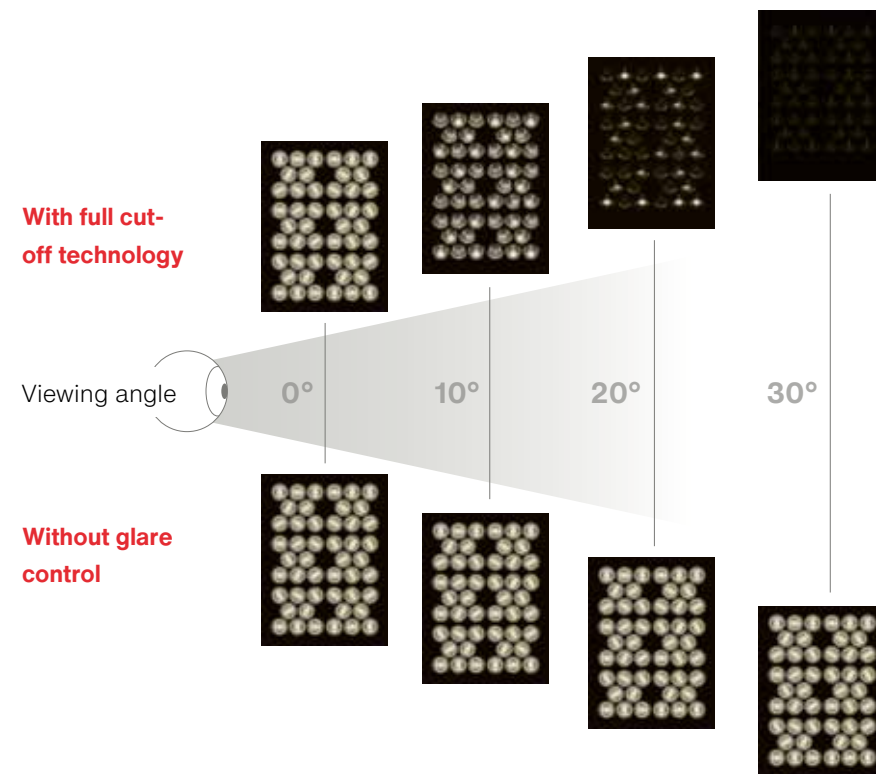

- Perfect bundling of light prevents scattered light.
- The remarkable effect: without latent, distracting stray light, spectators experience the action on the field as being more direct, sharp and color-intensive.
- Other manufacturers don't include glare control. The result: the light source is directly visible from every viewing angle, reducing visual comfort.

1
Project: Olympiahalle, Munich, Germany
Product: Sirius*

2
Project: Kristiansund BK, Norway



Lighting technology

Light is the top priority for us. But that doesn't mean the luminaires can't be beautiful too. And light is just the nucleus for integration in the digital infrastructure.

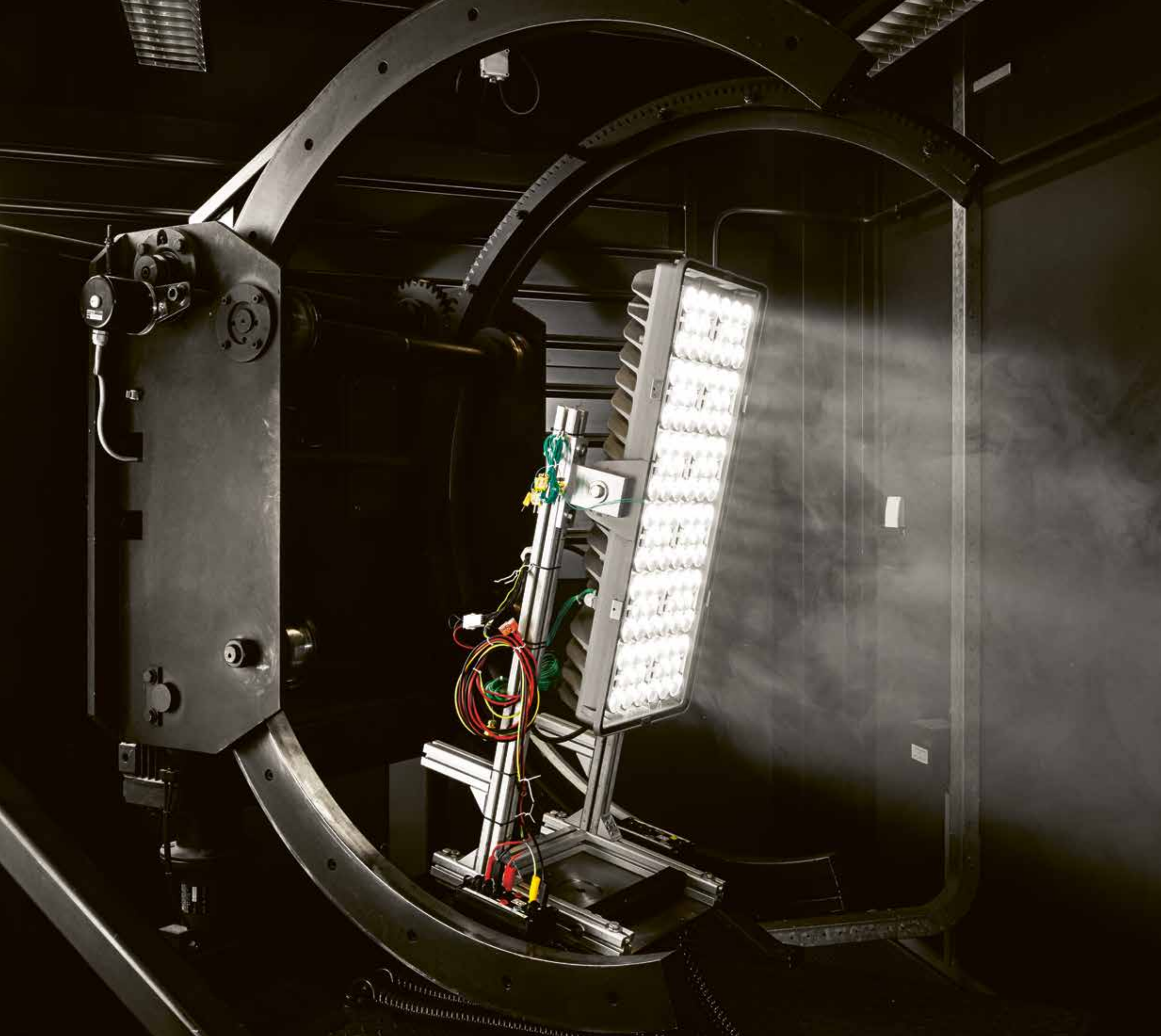

We admit it –
we love lighting
technology.

SITECO is a technology pioneer with more than 150 years of experience. CLO 2.0, full cut-off, free-form reflector technology with a globally unique silver coating process. We stand for more than 200 patented lighting technologies with diverse application options for you and your future. We offer integrated development of luminaires from a single source – from optics, mechanics and thermal design to control electronics and intelligent networking via lighting management, building management and smart city systems. The perfect integration of hardware and software designed and engineered in Germany.

**SITECO stands for exceptional
lighting technology.**

Licross® Trunking

14 cores and full flexibility are a must-have for tomorrow.

45 years of experience – trunking *Made in Germany* perfected in our new Licross® trunking system.

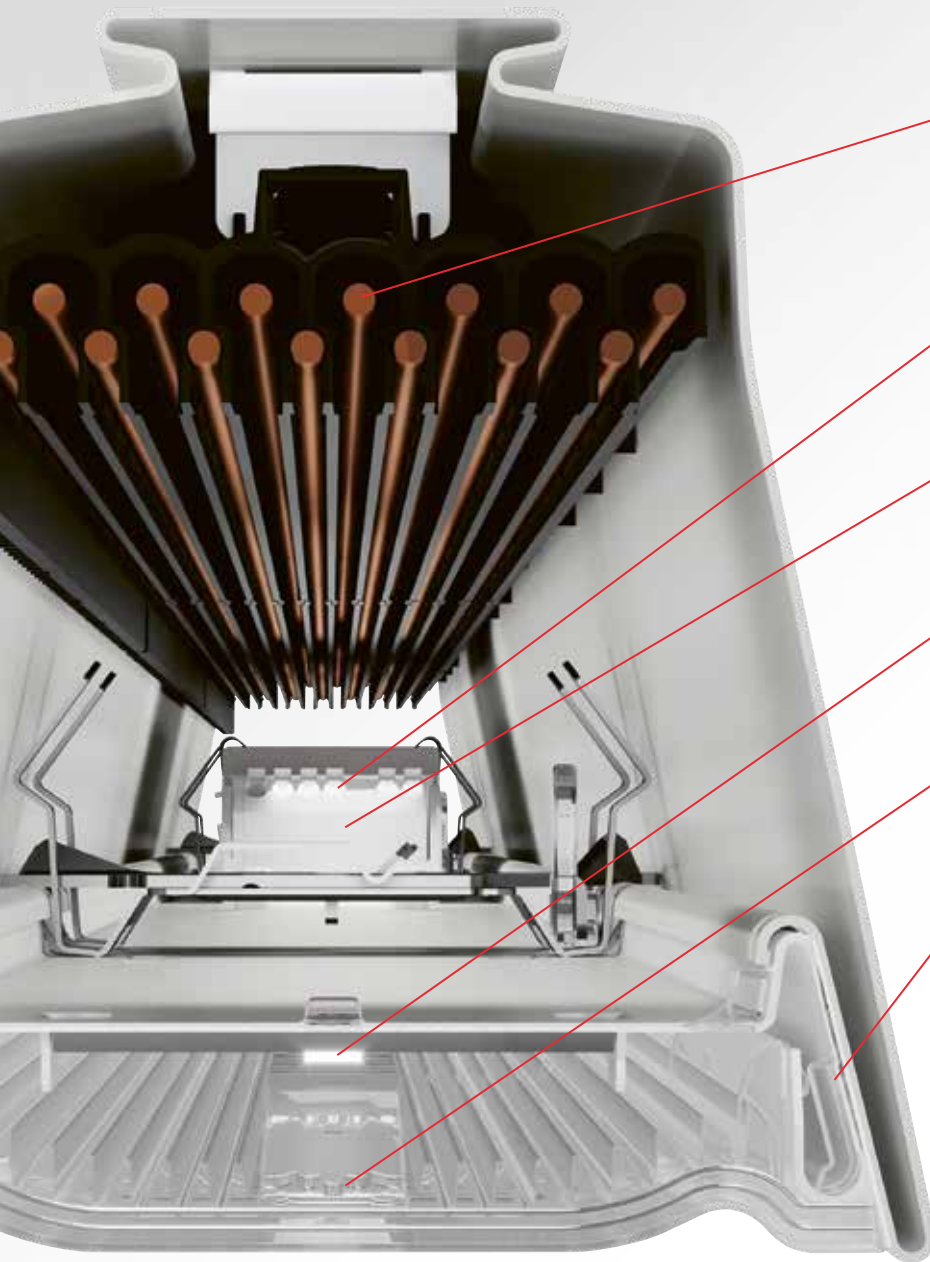

14 cores for optimal networking, diverse enhancements and integrated emergency lighting – and easy to install with click system

System service life up to 100,000 hours for sustainable and plannable investments

Maximum photometric efficiency of up to 200 lm/W for low operating costs and quick payback times

Optimum glare control up to UGR < 19 and high illuminance for safety and high visual comfort

The ideal basis for SITECO HCL^{live} to enhance motivation and well-being

One-for-all concept with diverse luminaire inserts and a unique combination of multi-lumen capability and CLOi for maximum adaptability

Licross® luminaire inserts

One product family with the right technology for any application.

Whether general, zonal or accent lighting or spotlights, shelf or wallwasher applications. Licross® lighting inserts offer the greatest possible freedom of choice with needs-oriented specifications and made-to-fit configurations. Additional customizing options provide even more flexibility.



Licross® Recessed

- Easy to achieve needs-oriented illumination thanks to a wide range of light distributions
- Uniform design with rail flush integration

Licross® Protected

- Strong resistance and suitability for ambient temperatures up to 50° C throughout the service life
- Highly robust system with protection ratings up to IP64 / IK06 with high luminous flux of up to 14,000 lm

Licross® Performance

- Special optical technology for excellent visual comfort with up to UGR < 19 – ideally suited for computer workstations
- Attractive interior design with up to 23 % indirect light component – ideal for SITECO HCL^{live}

Licross® Spot

- Powerful, point-based light sources for brilliant scene-setting and optimized light distribution
- Outstanding accent lighting with coordinated optics and light colors for shelves, wall surfaces and aisle illumination

Licross® wall- / shelfwasher

- Accentuated lighting and outstanding color rendering for attractive interior designs
- Harmonious housing design with a slender shape that is also highly flexible thanks to numerous configuration options

All inserts are available in the following colors:



Setting the course for tomorrow today.

State-of-the-art lighting technology means maximum efficiency. That's not enough for us. We offer a system that becomes the backbone of your building infrastructure and goes far beyond lighting. A solution with maximum flexibility in application that is already equipped for the requirements of the future.

Licross® - the backbone of your digital infrastructure.

14 cores for a new level of networking.

Free lines in the Licross® trunking system enable ultra-fast data transmission to the device of your choice. Standardized Ethernet sockets installed by us in the trunking system enable the connection of a wide range of IT equipment such as cameras and audio systems thanks to an intelligent family concept.

This enables you to bundle smart technology on the luminaire and thus optimize the space and appearance of your building ceilings. At the same time, you can reduce the complexity of the systems control and the fire load of your building.

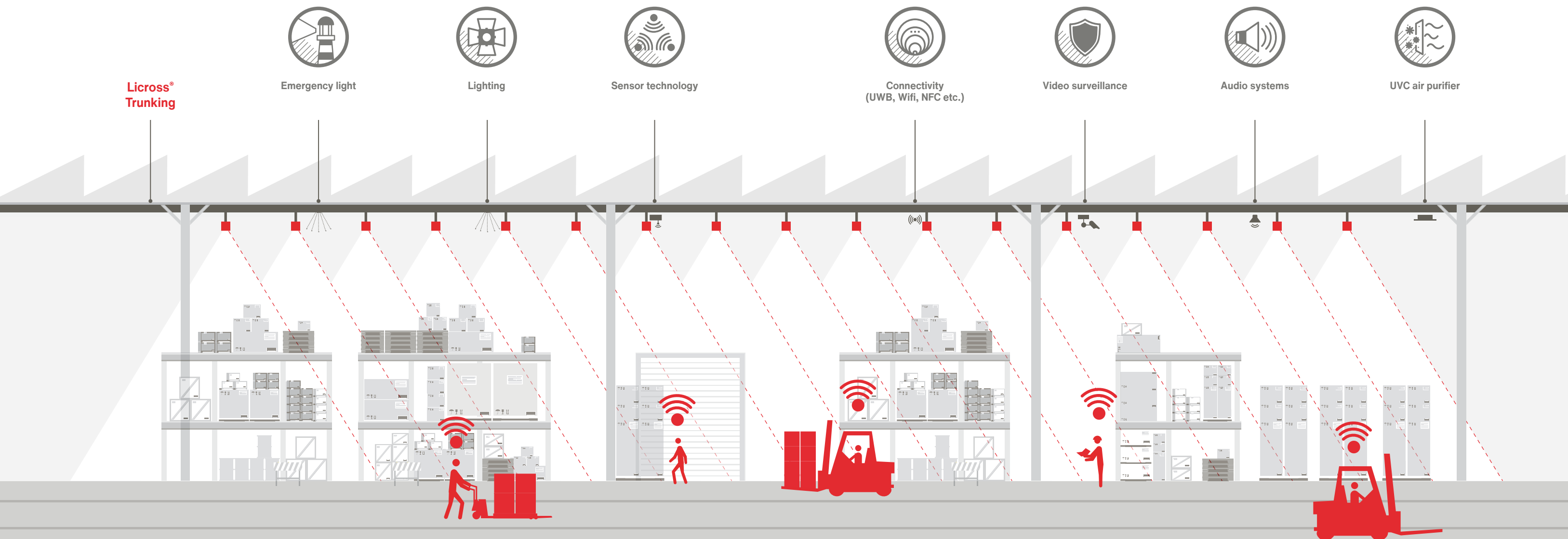

Streetlight SL 11

Indisputably the top model in technical road luminaires.

A modern design with outstanding light, efficient performance, reliable operation and intelligent control.

Especially durable thanks to robust diecast aluminum housing (IP66/IK09) with optimum heat dissipation, ensuring more than 90% residual luminous flux after 100,000 hours of service life

Highly efficient LED technology and tool-free opening allows quick maintenance of the luminaire for low operating costs

Digital interface for automatic communication when replacing ECGs or modules – no need for resetting or pre-parameterization

Highly flexible thanks to several sizes and optics as well as various light colors and housing colors

Maximum visual comfort on the road: precise, uniform and glare-free illumination via HD faceted reflectors with patented silver coating

Future-proof configuration thanks to various control options, intelligent dimming function, CLO 2.0 and open interfaces for Smart City applications, along with modular design for component upgrades





Urban luminaires with Module 540

Modular into the future of city lighting.

One fits all – a single module for a diverse spectrum of applications and efficient and elegant at the same time. With innovative LED technology for excellent visual comfort and decorative light control for high acceptance levels with the gener-

A wide range of options for illuminating urban spaces: Maximum compatibility enables selection from an attractive luminaire portfolio and significantly simplifies maintenance

- 1 Mushroom luminaire
- 2 Lantern Classic
- 3 Lantern Deluxe
- 4 City-Light Elegance
- 5 City-Light Plus
- 6 City-Light Pillar
- 7 Litepole
- 8 Litepole 2

- Easy installation and low maintenance thanks to future-oriented modular design for exchangeable LED module and gear tray
- Luminous module body as a visual guidance element with decorative day/night time effect

- High luminous efficacy lowers energy consumption and patented CLO 2.0 luminous flux tracking eliminates excess planning

- High visual comfort due to uniform illumination and excellent glare control – this can be further enhanced with a spreader element





Tunnellight TL 13

The absolute top model in tunnel lighting.

An innovative design for seamless continuous rows with the best lighting values – the optimum solution for maximum visual comfort and traffic safety in tunnels.



- Continuous row luminaire with innovative, extremely compact design for challenging mounting situations, made of high quality stainless steel
- Straightforward installation thanks to double-secured quick release catches for one-man assembly
- Very uniform illumination (UI to 1.0) and seamless continuous rows as a visual guiding element for high visual comfort and thus excellent traffic safety
- Outstanding efficiency of more than 185 lm / W for low energy consumption and minimal operating costs along with low luminous flux reduction for a long service life
- Controllable via 10 StepDIM or DALI, making it highly compatible with various control systems
- Sophisticated product concept with E-box for 10 to 12 luminaires and exchangeable driver reduces investment costs and simplifies maintenance thanks to a separate installation option

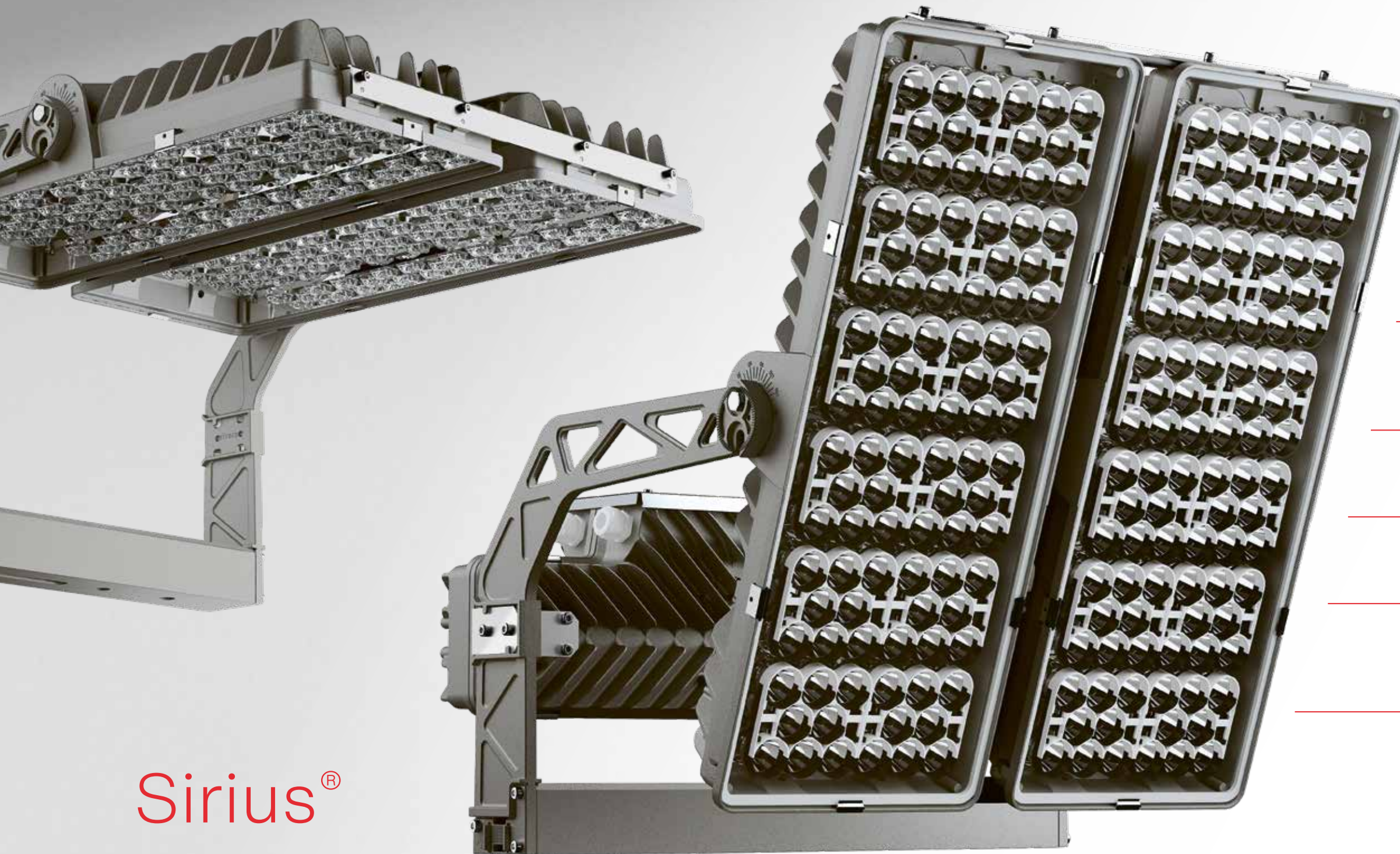

Sirius®

A dream of a floodlight.

A revolutionary floodlight system for sports and event lighting with unparalleled performance, efficiency and light quality.

- Full cut-off technology for maximum glare reduction (UGR 10) and perfect visual conditions
- Extremely high lumen output with up to 309,000 lm with a long service life of up to 100,000 hours for low and plannable investment costs
- Highly efficient thanks to silver reflectors and CLO 2.0 luminous flux tracking for low energy consumption and operating costs
- With a TLCI value of 96 at 5700 K for true-to-life color rendering and minimum post-editing work for broadcasters
- Modular driver system that can be installed at a distance of up to 150 m and with ECGs that allow separate control of the 4 LED modules – also via DALI/ DMX
- Extremely robust with high vibration stability, impact resistance (IK10) and protection rating (IP66) – also suitable for extreme conditions

Ball impact resistant with mechanical reinforcement of the housing – ideal for sports halls



High Bay

A new era for highbay lighting.

The universal hall lighting solution with a view to the future – as both a standalone luminaire and integrated in the Licross® rail system.

- Durable and reliable with service life up to 100,000 hours
- Optional sensor technology for light control depending on movement and available daylight
- Ready for a wide range of applications due to various construction sizes with lumen packages up to 64,000 lm, various light distributions and different mounting options

- Highly efficient lens-based optics system with high lumen-output LEDs and up to 200 lm/W
- Highly robust with protection class IP65 and impact resistance up to IK08; resistant to ambient temperatures up to 70° C
- High visual comfort due to very good glare control with UGR < 22



- Compact design with 64 x 64 mm housing for a streamlined design in harmonious proportions
- Seamless continuous row mounting: integration of the driver behind the LED modules enables seamless continuous rows and eliminates a large ECG canopy
- Also available with Tunable White function as the ideal basis for HCL^{live} applications for enhanced motivation and well-being
- Hybrid optic system consisting of lenses and reflectors – perfect glare elimination in longitudinal and transverse axes for high visual comfort even with large lumen packages
- Highest efficiency up to 160 lm/W thanks to state of the art LED technology for low operating costs – can be further optimized with optional presence and daylight sensors

Silica[®] luminaire family

Compact, streamlined and clever – office lighting in a new light.

Silica brings together simplicity and elegance in one high quality linear housing. The integrated ECG enables seamless continuous rows with a variety of individualization options. Silica[®] stands for the ultimate in lighting technology and is ideally suited for our HCL^{live} applications thanks to Tunable White.



- ① Silica[®] surface ceiling mounting
- ② Silica[®] recessed ceiling mounting
- ③ Silica[®] suspended mounting
- ④ Silica[®] Floorstanding luminaire

Available color variants:





Monsun[®] 12

The next level in damp-proof lighting.
The future-safe damp-proof luminaire – reliable, robust and with upgradeable intelligence.



• Multilumen technology with luminous flux up to 12,000 lm for maximum adaptability

• Highly robust with IP66 protection rating and suitable for outdoor use in ambient temperatures up to 50 °C

• Tool-free opening of the luminaire allows simple maintenance and easy upgrading of sensors

• CLOi also with ON/OFF models for standard-compliant lighting throughout the service life without excess planning and for optimized energy consumption

• Durable and reliable with service life up to 100,000 hours

Our complete
portfolio:
www.siteco.com



Lighting solutions

It works perfectly. That's all that matters to customers. We assume responsibility for integrated solutions. Anything to make your life as easy as possible.

And light is just the nucleus for integration in the digital infrastructure.

Complex is fine. Complicated is not.

Whether functional lighting or complex lighting solutions – each project is individual and depends on the desired functionalities, the existing framework conditions and the architectural demands. SITECO helps to define these parameters and convert them into an overall concept. We also speak the customer's language – so even complex technologies are always comprehensible. We can thereby ensure that all specific requirements are taken into account and successfully implemented in the project.

**SITECO – the planning and development partner
for your lighting solution.**

Light audit
Project planning
Lighting and electrical concept
Digitization and control solutions
Customization

Time and budgets are not unlimited.

Modern lighting systems require not only precise planning but also precise implementation. This often means high organizational and coordination expenditure. But it cannot mean the end of the project. The same is true for concerns about high investment costs. Systematic modernization of lighting systems usually pays for itself through lower operating costs.

We have a network of reliable partners – ranging from installers to programmers – who can provide turnkey solutions. We also offer individual financing solutions, such as monthly installments or individual leasing agreements. There are just two decisions to make: CAPEX or OPEX, and whether we should assume responsibility for maintenance of the solution as well.

SITECO guarantees the success of your project.

Installation and commissioning
Project management
Maintenance and servicing
Light as a service

If not now, then when.

Our specialists will show you the current possibilities and produce the facts at your location.

Hand in hand with architects, lighting designers and electrical contractors, we translate your functional – and design requirements into ideal technical solutions – and always make them tangible thanks to state of the art visualization.

SITECO enables pilot projects or a big step.

1

The SITECO audit provides complete transparency about the energy consumption and CO₂ emissions of your existing system.

2

Our lighting consultants design a solution that is based on your requirements and tailored to your needs.

3

The result: Clarity about your cost and energy savings potential – and completely comprehensible thanks to our detailed TCO comparison calculation.



Not open for debate: Everything has to be possible.

Now or later. Today we are creating the infrastructure that leaves all options open. From simple plug&play control to an integrated building management system – SITECO Connect gives you perfectly customized solutions. In doing so, we support you throughout the process: with planning, programming and commissioning.

SITECO Connect offers a new level of digital solutions.

SITECO Connect

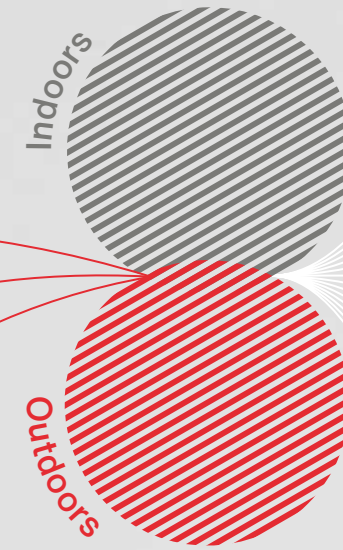

- SITECO Lifetime Assistant
- Data management
- Calendar and display function
- Building management
- Analysis and visualization
- ISO 50001 report
- Light Audit+
- Sensor technology Upgrading
- Multi-location networking
- Heat mapping
- Remote maintenance
- Integrated sensor technology
- HCL^{live}

Perfectly prepared for tomorrow's applications: SITECO Connect

... for industry

SITECO Connect networks industrial lighting for central control, monitoring and analysis functions – with real-time transparency of consumption and maintenance intervals. Easily integrated sensor technology offers additional application options: from the presence-dependent follow-me control to heat mapping of warehouse traffic to improve the flow of goods – a plus in terms of efficiency.

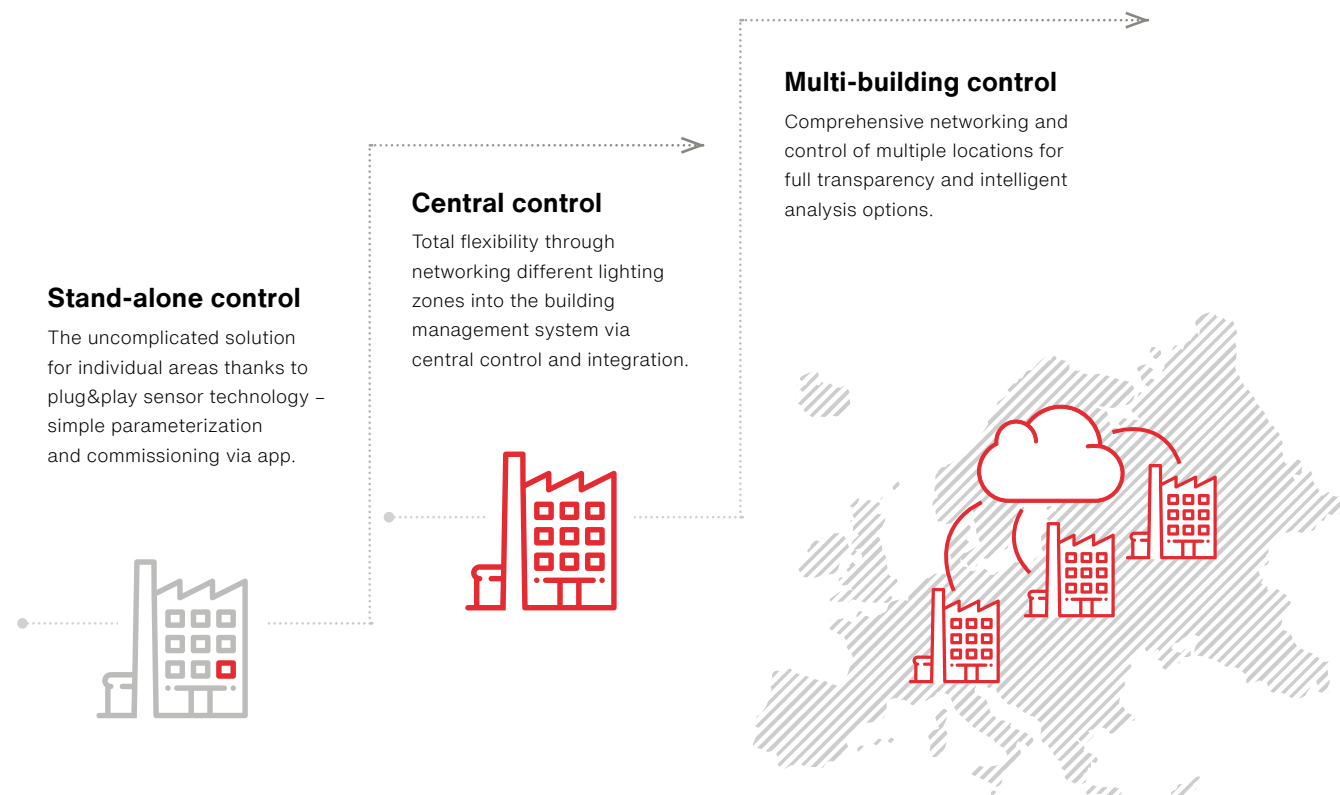

“Today we control locally, but soon across multiple locations.”

... for the office

SITECO Connect opens up the full potential of office lighting. Bluetooth control via app and intelligent sensor controls guarantee maximum ease of use. Integration in the building management system enables intelligent room management and optimization of ventilation and air conditioning systems. Your individual HCL^{live} lighting curve is also controlled with SITECO Connect and helps to enhance motivation and well-being at the workplace.



Project: OMNITURM,
Frankfurt, Germany
Product: Scriptus® (customized)
with intelligent SITECO Connect
control solution incl. HCL^{live}

... for retail

For the stores of the future, lighting concepts alone are not enough – they need solutions that merge lighting system and data infrastructure. SITECO Connect Digital and Audio use free core Licross® rail to connect additional building technology such as sensors, loudspeakers, wifi routers or cameras. Intelligently networked Beyond Lighting solutions create new application options, ranging from the optimization of ventilation and air conditioning technology to the real-time marketing at the point of sale.



Loudspeaker
for communication



Sensor for controlling
air conditioning

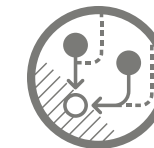

Sensor for customer
flow analysis



Camera for video
monitoring



Project: Royal Holloway College, London, Great Britain
Product: City Light Plus

... for urban spaces

Lighting doesn't have to be "always on". It makes more sense to use adaptive light with situation-based lighting scenarios: less light when possible, more light when necessary. Easy to integrate, sensor technology from SITECO Connect makes this possible. On the campus of the Royal Holloway College, the luminaires feature motion-dependent control – for greater safety, lower energy consumption and less light pollution.

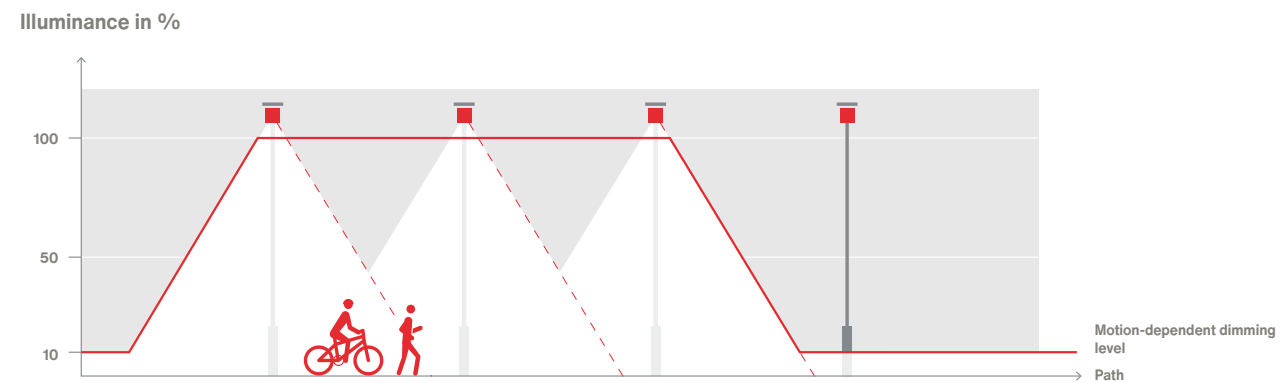

The Dashboard function provides continuous transparency about the state of the lighting system – from operating status to dimming level through to temperature updates.

Dashboard



The local gateway ensures real-time and protected communication.

Gateway

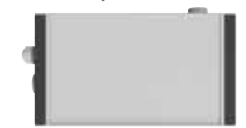

Sensors and telemanagement systems from various providers can be quickly and easily connected.

Smart Plug



SITECO Smart Interface with open interfaces (D4i and Zhaga Book 18) forms the basis for free system selection and flexible installation of control and sensor technology.

Smart Interface



Ideally suited for integrating motion sensors for a dynamic, continuous motion control, such as on a bike path – simple, efficient and without a gateway connection.

Smart Interface (lower page)



Smart City – technological flexibility for your neighborhood.

Intelligent control generates potential: less power consumption and light pollution thanks to controllable dimming and switch-off functions. Greater safety and protection from vandalism thanks to presence sensors. SITECO Connect gives you solutions tailored to your needs: From plug&play motion sensors as an independent controller to a fully connected telemanagement system.

SITECO Connect is your foundation for the urban services of the future.



Our HCL^{live} configurator lets us make complexity manageable and the solution tangible.

We know which questions to ask: from workplaces according to DIN standards to individual spatial conditions.

The result: precise parameters for optimized control of color temperature, illuminance and light dynamics.

For us, human centric lighting is more than just a definition.

On paper, anyone can do HCL nowadays. We transform it into reality. HCL^{live} is our promise to achieve the greatest benefit from HCL in your application situation. During the process we support and accompany you, from holistic planning, installation and commissioning to fine tuning.

SITECO HCL^{live} is a new dimension of light.

800,000

Special luminaires

in more than 1,000 projects

Adaption.

Modification of series luminaires

- Changing light color and color rendering
- Modifying housing dimensions, colors and mounting accessories

Combination.

Modular design system

- Versatile combination systems for your project solution
- Modular SITECO optic platforms as the basis for your project luminaire

Creation.

Special luminaire development

- Concept development and project management
- Construction planning and special luminaire design with an experienced development team

We live customer proximity through flexibility and speed.

Where the options in the catalog end, the almost infinite range of customized options begins. SITECO offers a broad spectrum of options for customized solutions thanks to its experienced team of designers and engineers. *Made in Germany* also means we provide additional flexibility and speed.

The right model for your requirements.

Each project is individual and based on the general conditions. The same is true for the right financing. SITECO offers a number of financing options – from installment payments to a full service operator model. In doing so, we focus entirely on your requirements and consult with you regarding financial implications and requirements.

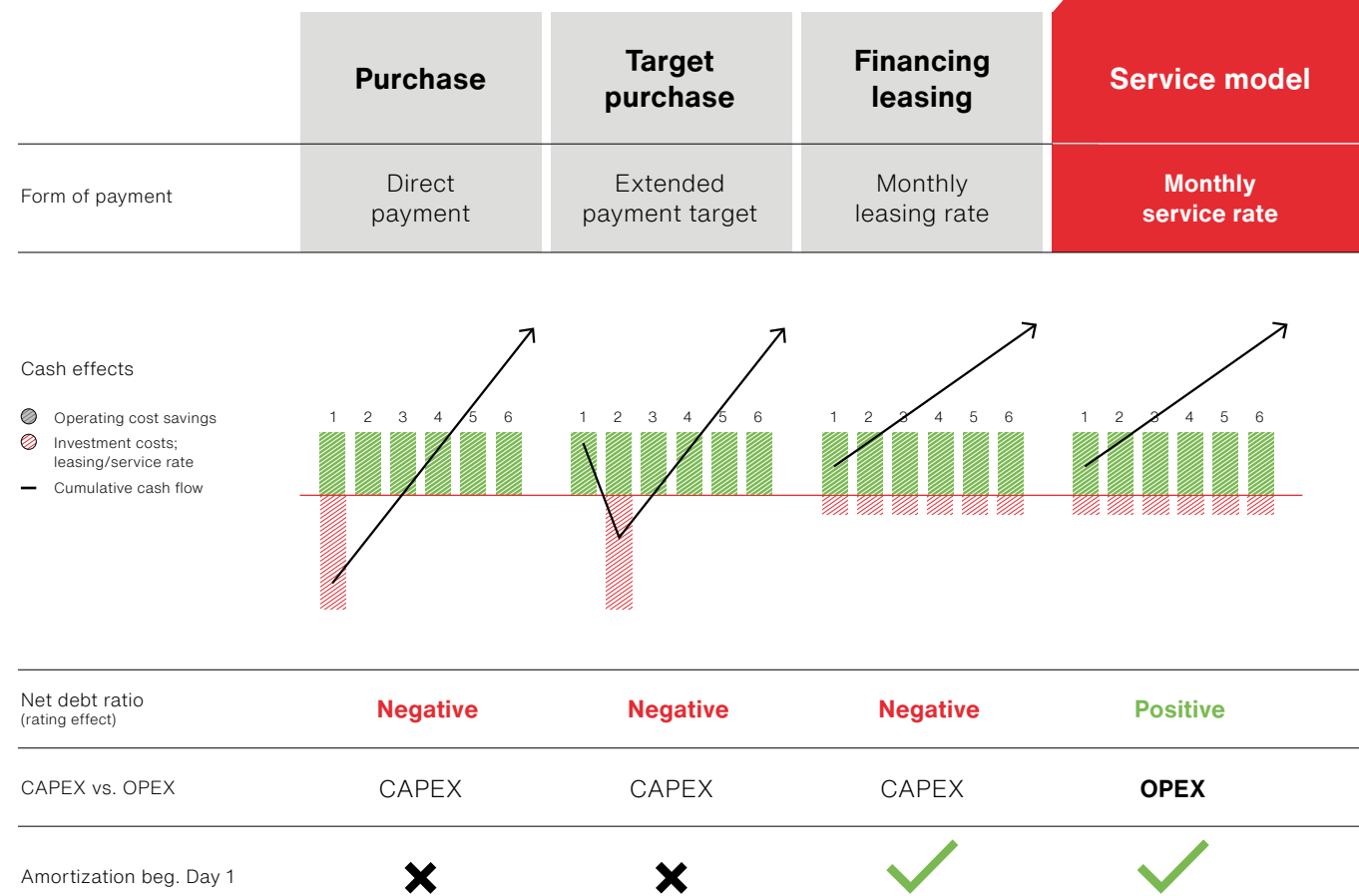

- **Flexible terms and installments** according to your needs
- **Savings** begin on Day 1 without capital expenditure
- **OPEX vs. CAPEX** – without negative impairment of rating-relevant financial figures

One rate – maximum service

Your time and your budget are not unlimited. That's why we offer a service that frees you from any effort for the entire service life of the system. With our service model, you get turnkey solutions from a single source – from planning to installation to maintenance. In doing so, we always provide the best product for your requirements. Our optional, digital services from SITECO Connect open up even more application options – a plus in terms of efficiency.

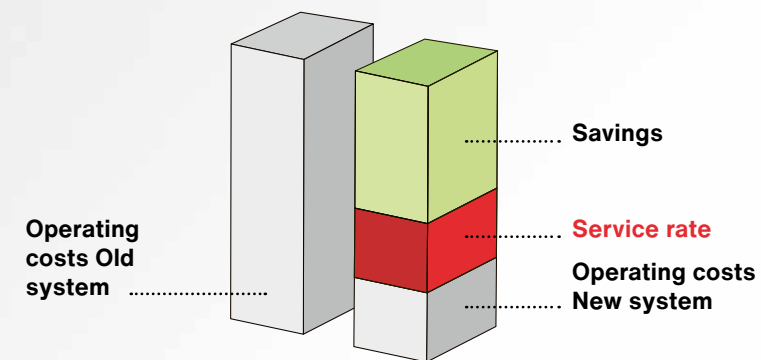
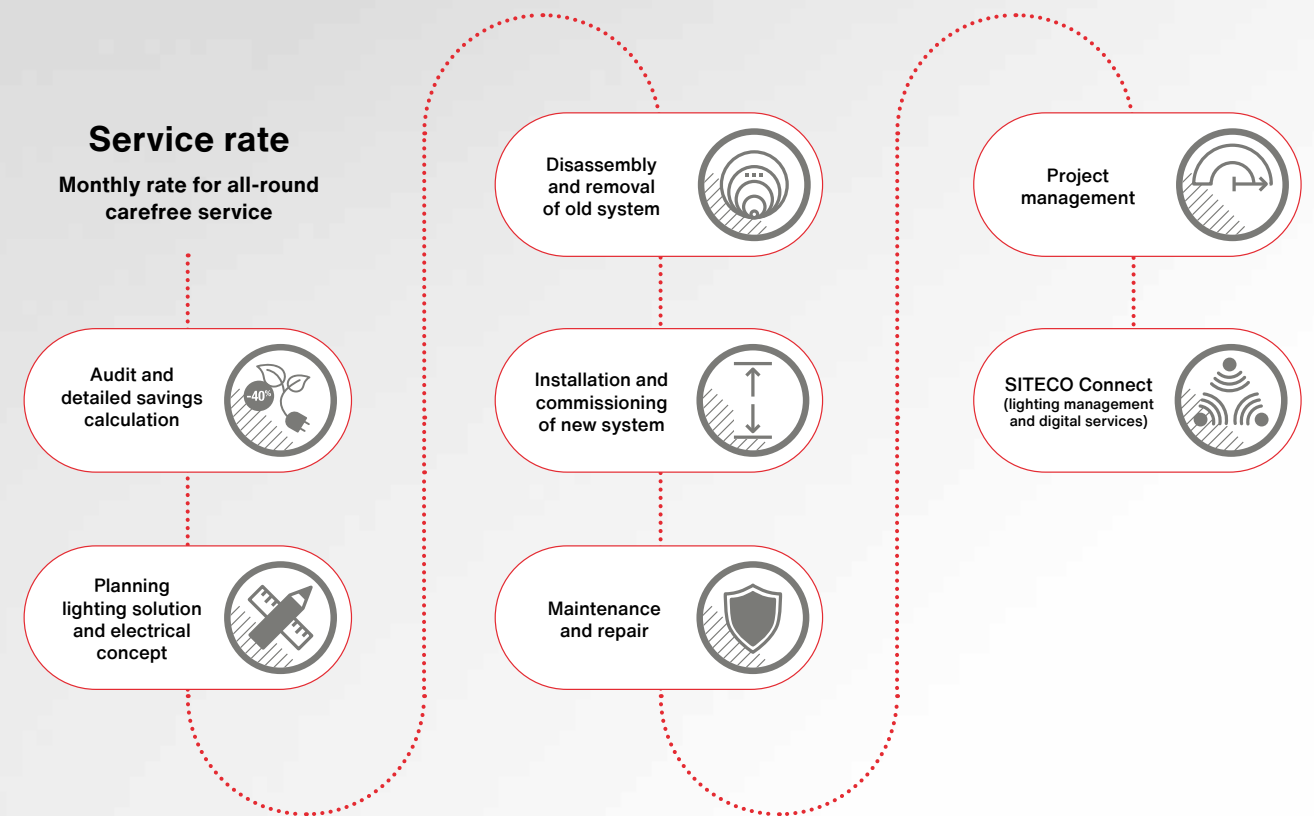

It has never been more worthwhile.
The saying 'Cash is King!' applies now more than ever. That's why we offer a service model that lets you earn money starting at Day 1 – financed from savings in operating costs, with no expenditure.

People

We have a passion for light. We are infatuated with the topic of light. Because light is such an important part of life, we fight for the future of light every day.

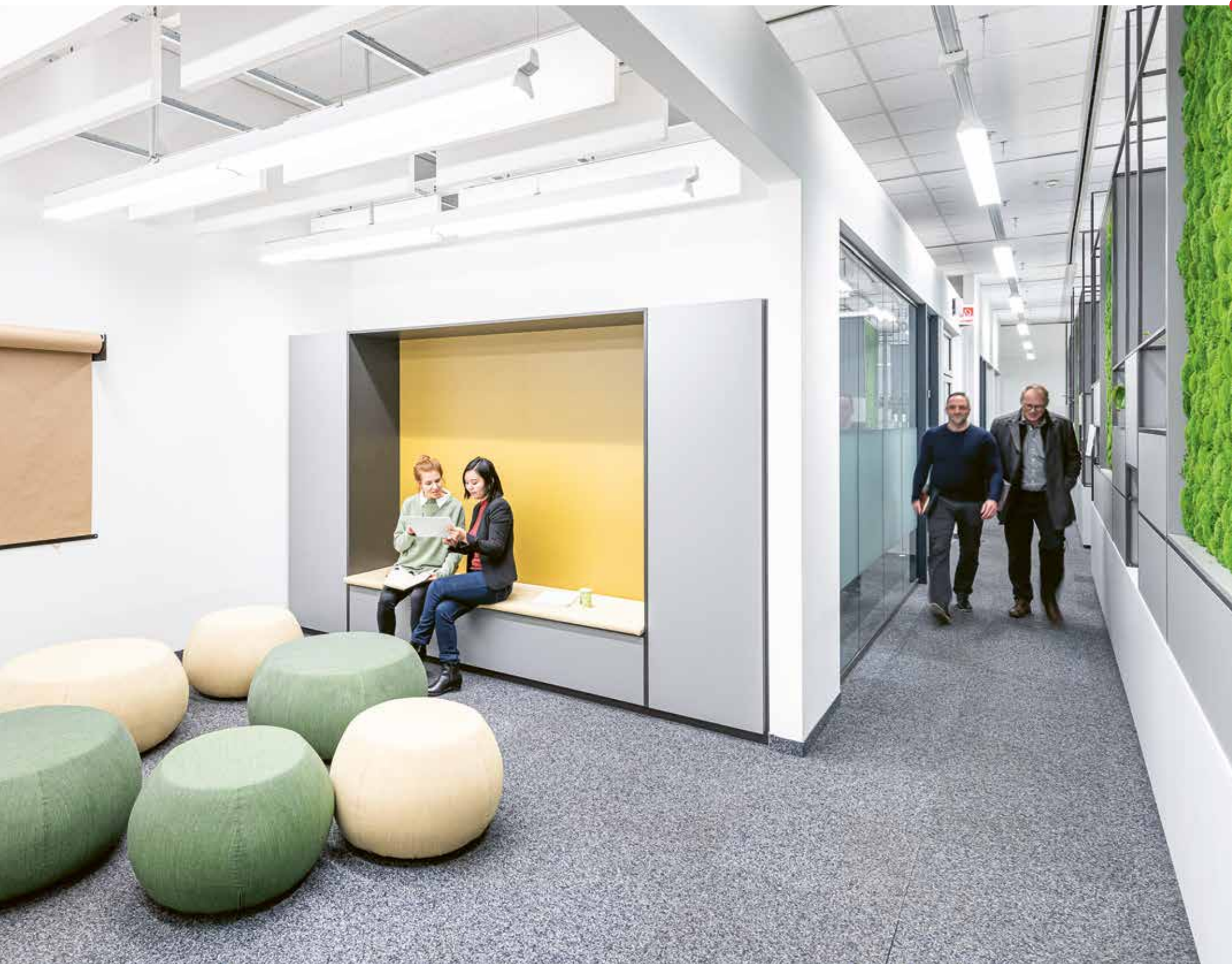

1
Customer Service Center

2
Silver coating

Longterm success requires being open to change again and again.

It is critical to have a high degree of entrepreneurial spirit at the core of an organization. In our more than 150 year history, our employees have witnessed a great deal: many accomplishments, and many turbulent times as well. But they have always ensured that SITECO will continue to thrive.

With great passion, strong motivation and a unique team spirit, our employees work their hardest each day to create the best possible solutions for our customers. Together, we will take advantage of the new independence to unlock even more entrepreneurial spirit. To focus on the important opportunities and challenges every day.

Putting the focus on people – shaping the future of light together.



36 Trainees

in 7 professions



1
Optics development

2
Training workshop

“At SITECO, entrepreneurship begins with training – personal responsibility and a culture that promotes open discussion apply from Day 1. It makes me proud to see the progress of our trainees day by day and how we can contribute to it.”

Sebastian Bauer, Master trainer in metal

“SITECO stands for exceptional optical technology – whether with the ELDACon microprismatic structure or silver-coated HD reflectors. The unstoppable drive to innovate is a central component in the SITECO DNA. Every team member is passionate about their topics and puts their heart and soul into the work.”

Katrin Schroll, team manager optics development



2

Let's talk about what
matters most to us:
the light of tomorrow.

Siteco GmbH

Georg-Simon-Ohm-Str. 50
83301 Traunreut
Germany
Tel. +49 8669 330
info@siteco.de

www.siteco.com

We are grateful for the long-time confidence
of our customers and partners. And for the
dedication and passionate commitment of all
our employees. Together, we are taking the
light of sustainability, flexibility and quality
of life into the

Future.

For reasons of readability, the brochure largely dispenses from using gender-specific formulations.

If personal designations are only provided in masculine form they refer to people of any gender.

Order number 810P016GB | SITECO Marketing 09.2020 | Technical modifications and errors reserved.



