

siteco



# Floodlight **FL 21**

Reliable as always.  
Flexible and smart like never before.



Types,  
data sheets,  
configuration –  
all at a glance:  
**Floodlight  
FL 21 iQ**



# Floodlight FL 21. A family that's flexible like never before.

Floodlight FL 21: The SITECO product family is well known for its lighting quality and reliability. And thanks to this product line's robustness, perfect for parking areas, halls, industry, sports and recreation. The latest generation is more intelligent, more flexible and more environmentally conscious than ever before.

Three sizes. One shared, consistent design. And all the details that modern lighting needs: Like, for example, abundant models for connecting and brand-new control features. This makes light not only flexible, but smart as well.

**Floodlight FL 21: the versatile multitalent with a high IQ!**

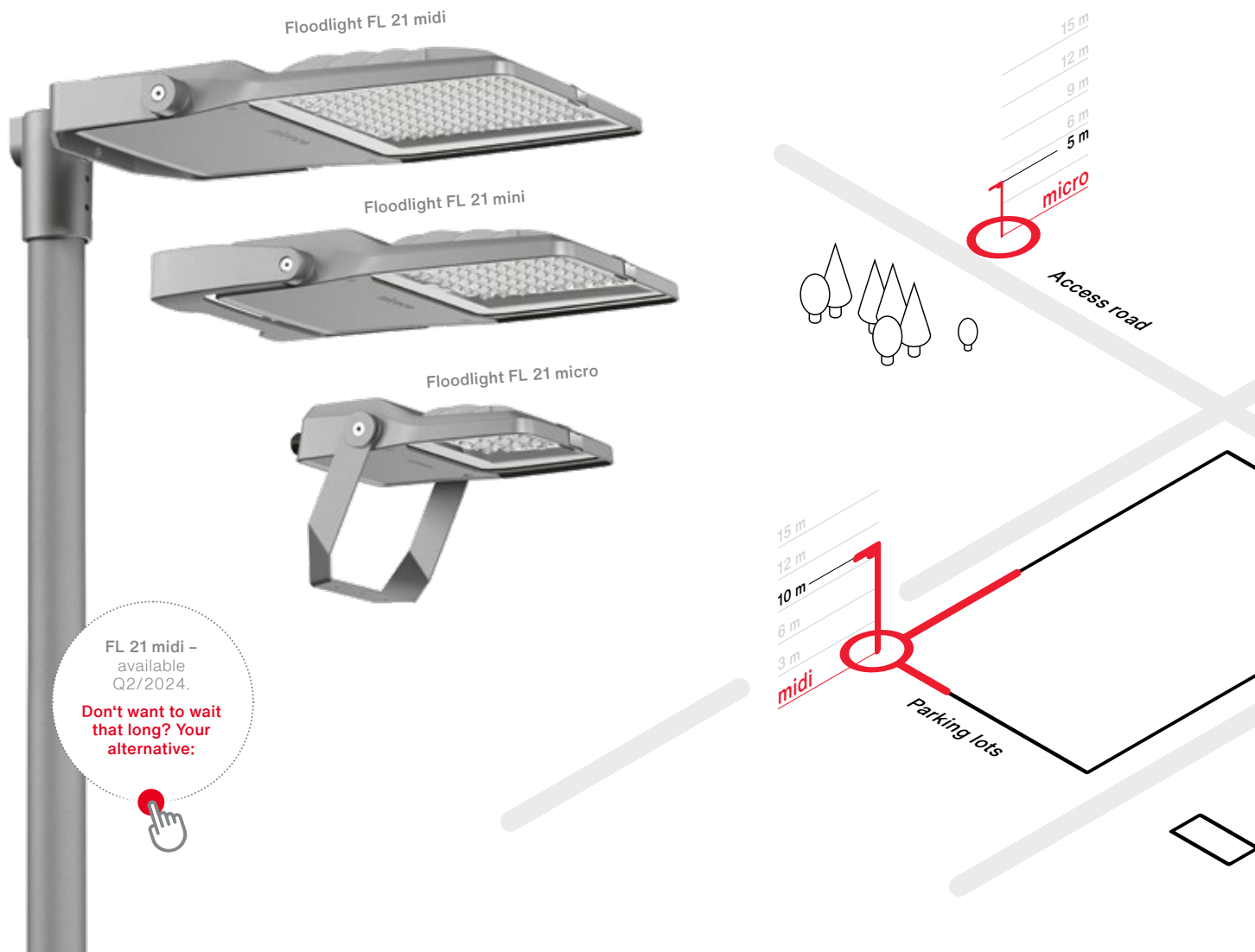

**As smart and convenient as you want it to be.**

Fulfills your individual requirements: With DALI, multilumen, Smart Interface and SITECO iQ, Floodlight FL 21 is ready for every scenario. How smart would you like it to be?

**A versatile design.**

Simple support bracket or stylish design bracket? Whether your project involves mast-top mounting or mast-side mounting or even mounting two floodlights on a mast: Floodlight FL 21 flexibly meets your installation requirements as well.

**Environmentally friendly down to the smallest detail.**

“Green” lighting addresses many issues related to environmental protection: Separable materials and exchangeable components. The right kind of packaging. Floodlight FL 21 stands for all this and consequently makes a real contribution to environmental protection.

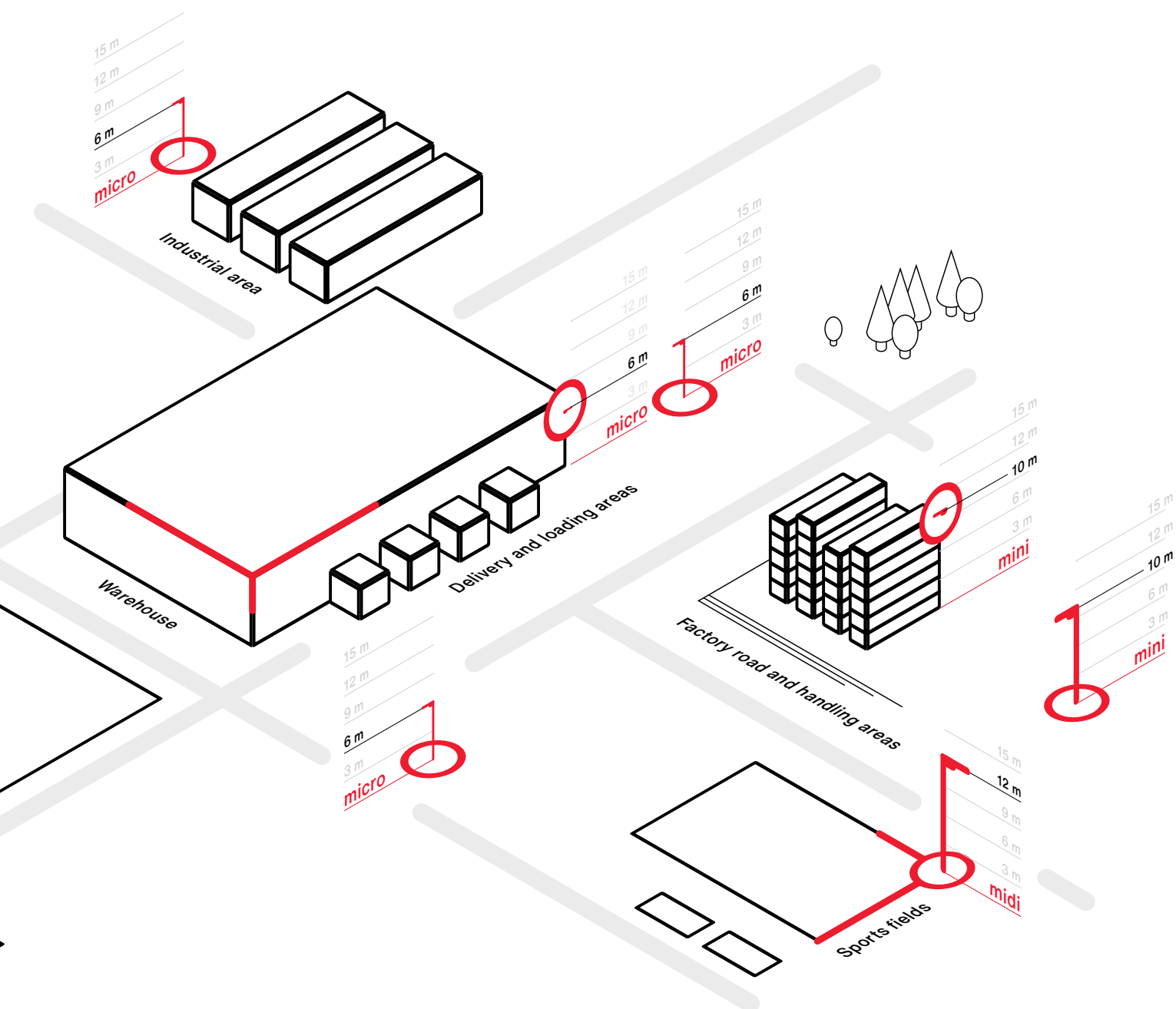



## Flexible installation? And how!

Hardly any other floodlight family boasts as much flexibility and versatility as Floodlight FL 21. No matter if mounted on a wall, crossbars or a mast. No matter if mounted low or high on canopies and facades. FL 21 masters different looks equally well: stylish using a design bracket and reserved using a support bracket as well as powerful when you mount two floodlights on a mast.

**Installing Floodlight FL 21 is also more flexible than ever before.  
And always meets your needs.**

**Bracket and mast connections  
as well as accessories at a glance:**

**Bracket luminaire**

**Design bracket**



**Support bracket**



**Mast luminaire**

Used for both mast-top- and mast-side-mounted luminaires.

**Mast flange**



**Mast bracket**



**Single/dual connection** for all sizes

- Mast flange for 76 mm, 60 mm and 42 mm
- Available for mast-top- and mast-side-mounted models



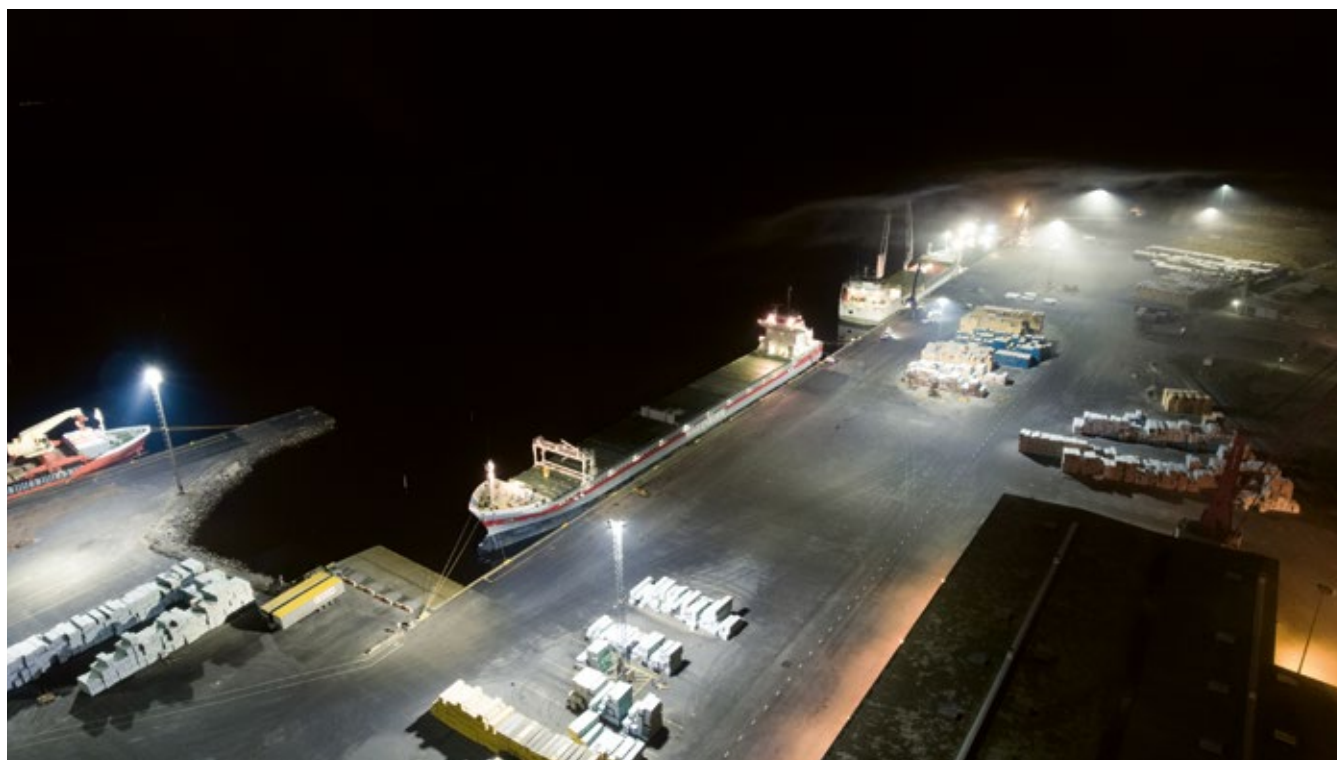

# Used everywhere. Always indestructible.

This floodlight is not made of sugar:  
Salty spray, chlorinated water, emergency  
operation: Floodlight FL 21 holds its own  
no matter how tough the environment.

The floodlight provides homogeneous  
illumination to help with quick orientation  
and safe maneuvering and loading.  
And it creates the kind of atmosphere  
where you can let off some steam and  
join in the excitement.

## Weather resistant.

Those who work hard need reliable  
support. Boasting a **C5 corrosion  
protection class** and **IP66 rating**, the  
FL 21 is a reliable floodlight even under  
extreme conditions.

## Increase safety exponentially.

Out on a parking lot in the evening hours?  
The right lighting makes the experience  
feel much safer. Floodlight FL 21 provides  
homogeneous illumination all the way into  
the most remote corners – thanks to the  
new PL64 and PL33T light distribution  
system. A further advantage: The FL 21  
is **DC capable** – and that means you can  
count on the floodlight when it's in  
emergency operation.



### **Tough as nails.**

Where sports are played and the balls come flying fast, your lighting system has got to be able to take it. That's why the FL 21 midi has been thoroughly tested to ensure it's **ballproof**.

Available in  
5,700 K,  
CRI 90



### **Glare-free.**

In demanding environments, you need outstanding **glare-free lighting**. The solution for swimming pools is called **Mirrortec**: The floodlights disperse light through a multifaceted system, producing an **especially uniform** light distribution. A further advantage: The series version of Flood-light FL 21 is already resistant to chlorine.

# Made for extremes.

While always working  
at top efficiency.

**Absolutely exceptional:** IP66, IK08,  
CE certified, ENEC certified,  
D-mark certification, ballproof,  
suitable for swimming pools.

**Durable, exchangeable materials,**  
including non-yellowing PMMA  
lenses and glass cover.

**SITECO iQ Street Remote:** Light level can  
be suitably and conveniently adjusted over  
Bluetooth and the iQ app according to use.







● **Maximum glare control** thanks to an excellent asymmetric light distribution system.

● **High thermal stability:** up to 50 °C outdoors, 40 °C indoors.

● Exceptionally steady luminaire due to **high vibration stability**. Perfect for outdoor use in very exposed areas.

● **Extreme snow load stability** with a pressure load of 400 kg/m<sup>2</sup> – that means a snow load zone with snow depths of up to 1.5 m.

● Luminaire that preserves the natural darkness of night **with zero light pollution** and a warm white light color.



**Light. Right where  
it's needed.**

Without disturbing  
residents or nature.

**0%**  
light pollution



# Gentle on the environment like never before.

Light has a special responsibility to assume as human settlements encroach more and more on the habitats of wildlife. And SITECO does as well.

The FL 21 luminaire family directs its light downward with maximum precision. The night sky remains dark, adjoining areas, too.

But environmental protection starts even earlier at SITECO: We don't glue materials together, which means components can be separated by type. Our deliveries come in reduced packaging free of Styrofoam.

### **Targeted with no light pollution.**

Thanks to an asymmetrical light distribution system, FL 21 floodlights direct light with targeted precision onto the respective surface – and only there. Without scattered light or light pollution to contend with, the sky remains dark and nature and the neighborhood undisturbed.

### **Environmental protection – through and through.**

Not only does the design score points thanks to a flexible modular system.

Modular thinking also infused the FL 21's inner values: The ECG and LED module are cleanly separated, which makes replacing the components easy.



**Securely packaged.**  
The FL 21 is shipped without using Styrofoam and plastic.

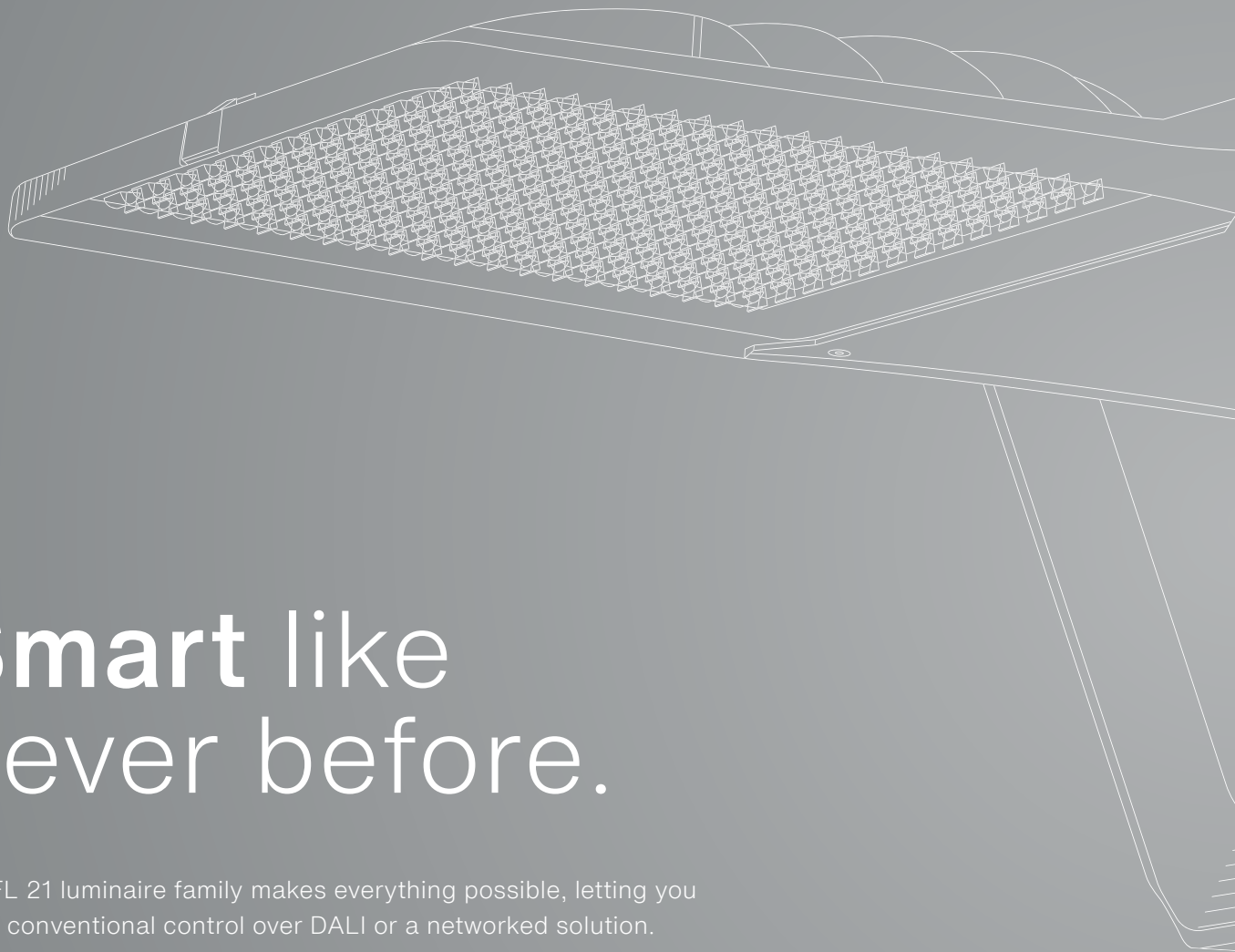

# Smart like never before.

The FL 21 luminaire family makes everything possible, letting you use a conventional control over DALI or a networked solution.

Smart Interface transforms your lighting into a future-proof control center. It communicates with many standard radio-based control systems and sensors. This is where SITECO iQ, the patented control electronics we developed in-house, delivers big by helping you unleash the full potential of intelligent control.

You can conveniently manage everything using the iQ app.

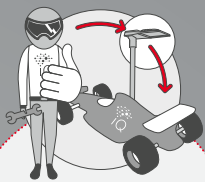

### Auto Match

Exchange ECGs in no time – without reprogramming.

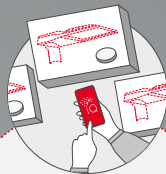

### Desk Remote

Adjust luminaires in the workshop without opening any luminaires or shipping boxes.



### Street Remote

Configure luminaires from the sidewalk or from a vehicle “on the fly.”

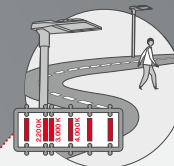

### Color Switch

Get prepared now for future environmental and animal-protection guidelines and be able to react flexibly.

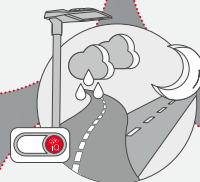

### Light Switch

Boost visibility and safety for road users when the weather changes.



### Smart Wire

Dim using existing control wires and intelligently switch between dim profiles, light colors and light distributions.



### iQ app

With a smartphone, always have the full range of functions at your fingertips.

### Lumen Switch

Flexibly adapt the luminaire’s luminous flux to its location as well as accommodate residents’ requests.

### Night Set

Automatically adjust nighttime reduction to multiple levels and switch between two profiles. (for example, weekends and weekdays)

### Surge protection

With integrated surge protection, ensure your luminaires enjoy a long life.

### Smart Interface

Using standardized Smart Interface, intelligent functions can be combined according to Zhaga book 18.

### Light Fading

Ensure a pleasant city atmosphere with soft dimming and no irritations.

### CLO 2.0

Constant luminous flux control from SITECO takes into account ambient temperatures and dimming. This also helps to save energy.

### Temp Guard

Reliably protect luminaires against overheating and ensure a long service life even at high temperatures.

### Fuse Plus

Keep existing circuit breakers and use them for additional luminaires.



Color Switch Light Switch Smart Interface Night Set Lumen Switch Light Fading **CLO 2.0** Fuse plus Temp Guard Lumident 3 plug with reverse polarity protection Surge protection Auto Match Desk Remote **Street Remote** Smart Wire Color Switch Light Switch Smart Interface Night Set Lumen Switch Light Fading **CLO 2.0** Fuse plus Temp Guard Lumident 3 plug with reverse polarity protection Surge protection Auto Match Desk Remote **Street Remote** Smart Wire Color Switch Light Switch Smart Interface Night Set Lumen Switch Light Fading **CLO 2.0** Fuse plus Temp Guard Lumident 3 plug with reverse polarity protection Surge protection Auto Match Desk Remote **Street Remote** Smart

# SITECO iQ CLO 2.0

## As much light as needed – automatically.

Wind, rain and temperature impact the amount of power needed to maintain a constant luminous flux. The lower the ambient temperature, the less power LEDs have to consume to achieve a given luminous flux level. This means that at ambient temperatures below 25 °C, the luminous flux of typical LED luminaires producing a consistent intensity will be higher than planned – and more energy will be used than is necessary.

SITECO CLO 2.0 controls the current feed and accounts for outside conditions, thereby ensuring there's always exactly as much light as is really needed. In concrete terms, this means potential energy savings of 7 %!

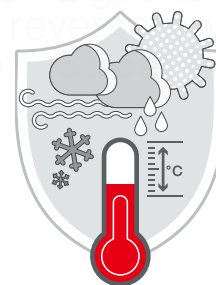

Readjustments are made continuously depending on the surroundings and dimming behavior.

CLO 2.0 provides up to **7 %** energy savings

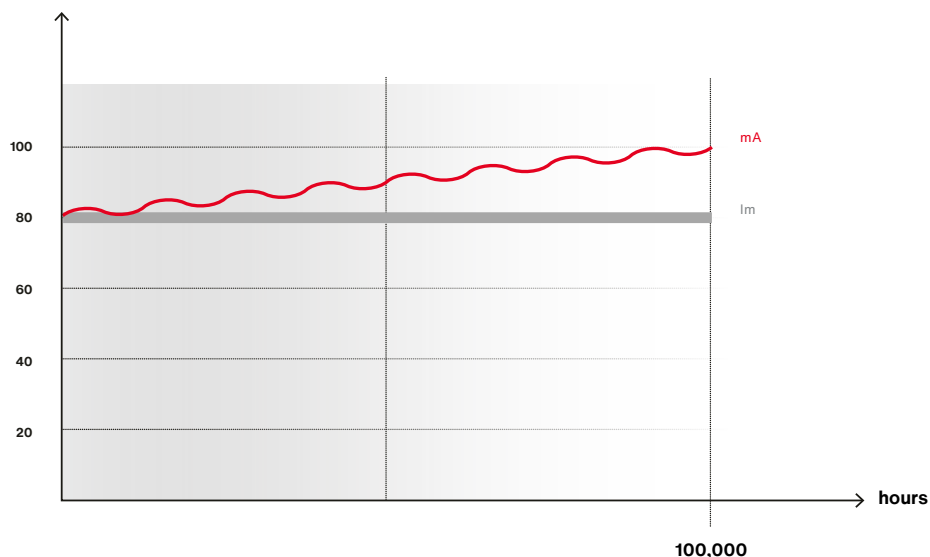

# SITECO iQ

Because we know  
what challenges you  
are facing every day.

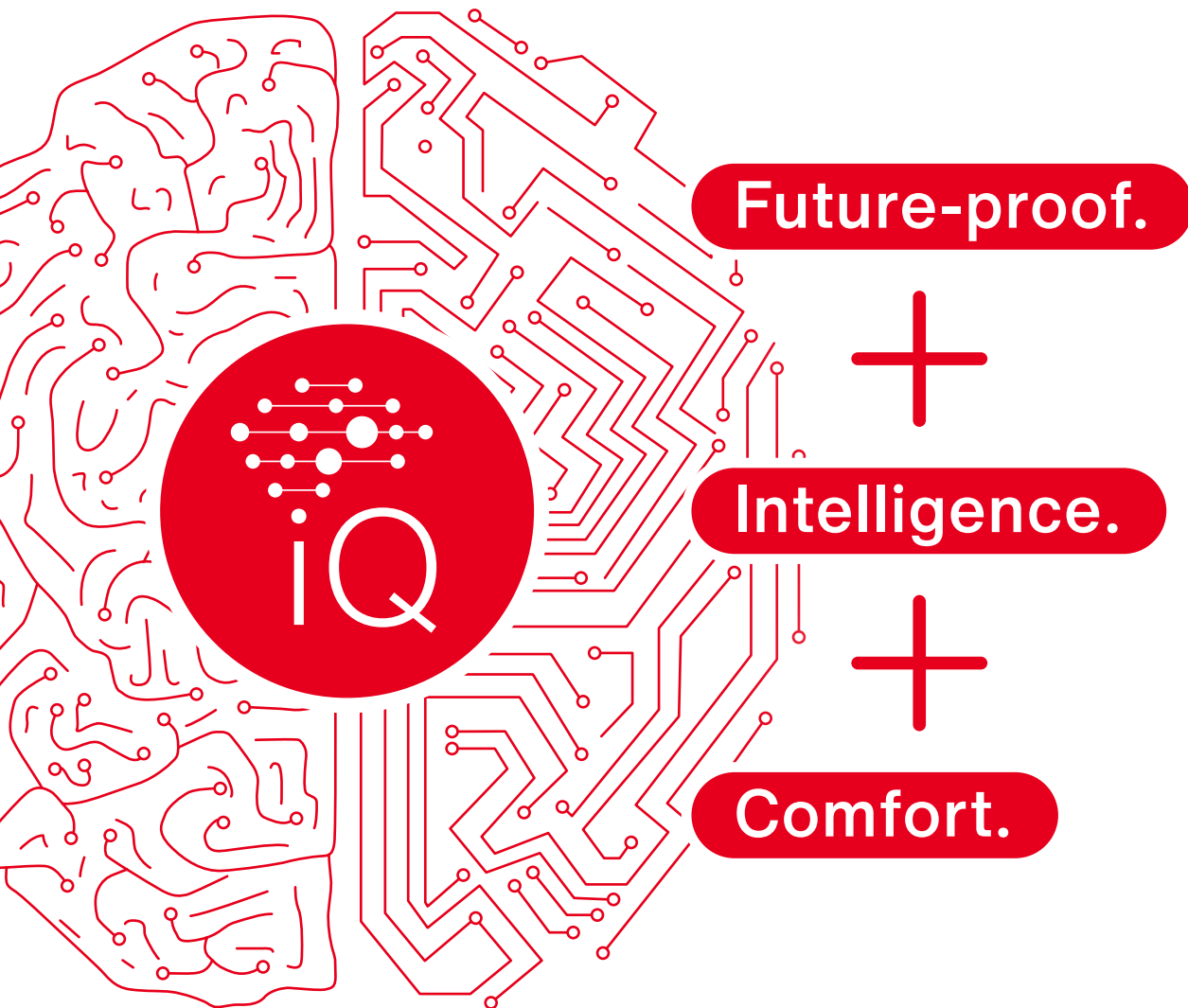



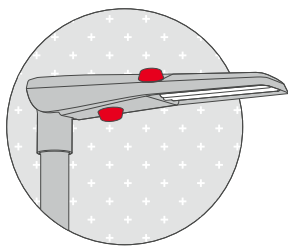

**Smart-Interface**

**Intelligent light at its peak – for maximum future viability.**



**Street-Remote**

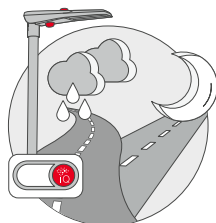

**Light-Switch**

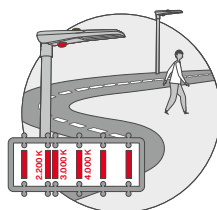

**Colour-Switch**

**Intelligent additional features – for maximum flexibility.**

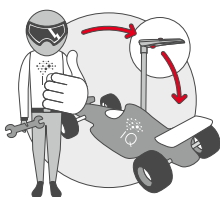

**Auto-Match**

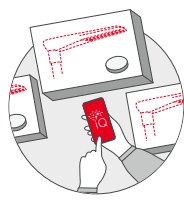

**Desk-Remote**

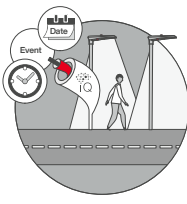

**Smart-Wire**



**Night-Set**

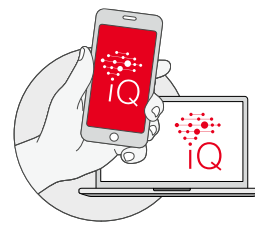

**iQ App & Webtool**

**Intelligent features – for maximum convenience in everyday use.**



**Lumen-Switch**

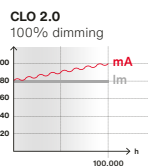

**CLO 2.0**

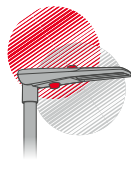

**Light-Fading**

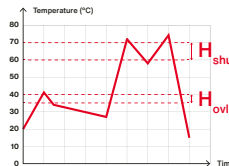

**Temp-Guard**

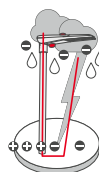

**Surge Protection**



**Fuse-Plus**

**Intelligent foundation – for maximum efficiency.**

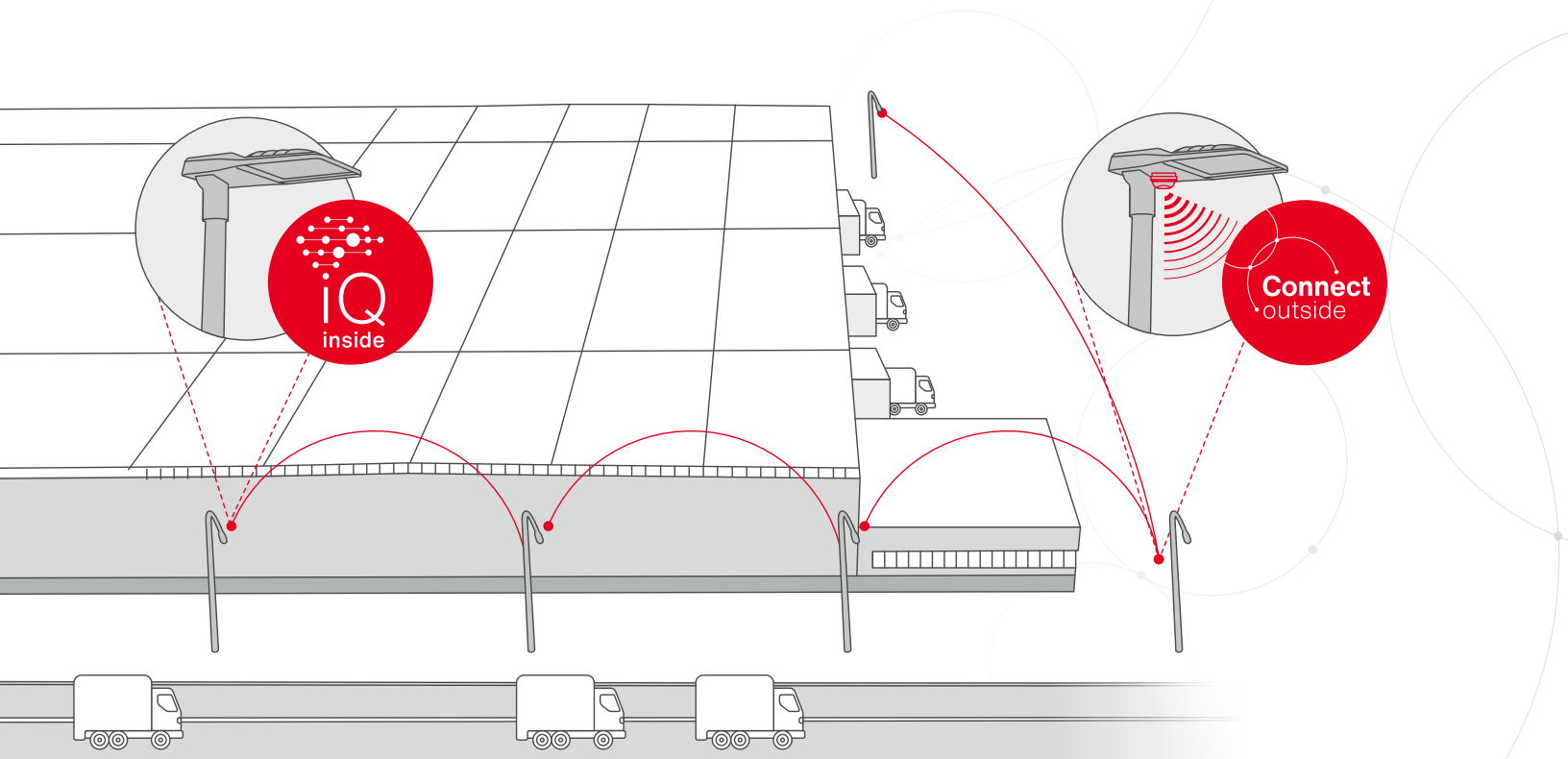

## Get started today with SITECO Connect

### **From simple control to a connected system.**

Ready when you are: You decide when and what steps you want to take to upgrade to modern control technology. Floodlight FL 21 and Smart Interface give you complete flexibility. You can gradually adopt the control technology and retrofit elements at any time.

Floodlight FL 21 lets you think in terms of planning options. Smart Interface provides standardized interfaces according to Zhaga Book 18 and D4i as well as NEMA, so that many radio-based control systems and sensors are compatible and plug & play installation is possible at any time.

This gives you independence and future-proofs your lighting systems.

# 100% flexibility

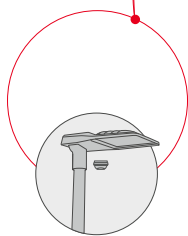

## SITECO Connect 31: Single luminaires

- Individual luminaires are activated or dimmed with a local motion detector.

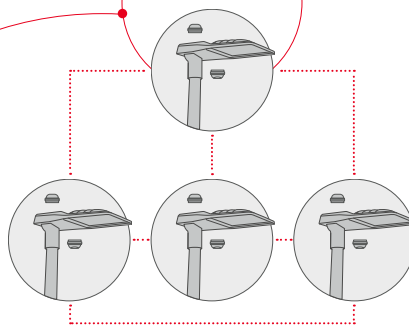

Configure and diagnose on-site with a USB transmitter on a laptop

## SITECO Connect 21: Several luminaires connected locally

- Several luminaires are connected via radio.
- The luminaires in the network communicate and synchronize among themselves.
- The luminaires are synchronously or continuously activated and dimmed.

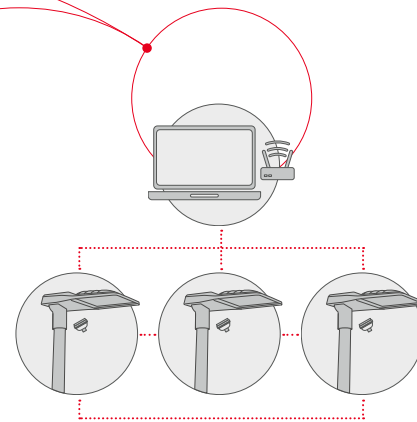

Collimate and diagnose using web remote access

## SITECO Connect 11: Several luminaires connected with remote access

- The luminaires are connected via radio.
- Settings can be defined from the office through the network with remote access and status messages sent automatically.
- Existing inventory and workflow systems like luxData by sixData can be used as a master.

### Modern lighting control offers many advantages



Improves traffic safety and protects against vandalism



Contributes to sustainability by protecting environmental resources and wildlife



Boosts energy efficiency thanks to needs-based dimming

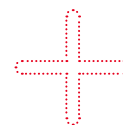

Optimizes operational management using current diagnostic data and documented systems

# Our light distribution systems. Precise as always.

Uniform, efficient and exceptionally precise: Floodlight FL 21 delivers the latest generation of planar lighting thanks to powerful LED units and state-of-the-art lens technology. Facades and advertising spaces can also be dramatically presented. The precisely calculated light distribution options streamline work for planners, too: The name already indicates the maximum width and depth of the beam spread.

**For improved light through precise planning.**

## Light distribution options

Planar lighting		
1st position in name Typical application area	2nd position in name Wide beam spread with its factor to the light point height	3rd position in name Narrow beam spread
PL = planar	4	3
	5	2
	6	1

Spotlight illumination	
1st position in name Light characteristic	2nd position in name Half scattering angle specified in degrees
RS = rotationally symmetric	17

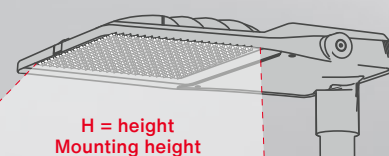

W = width  
Narrow beam spread

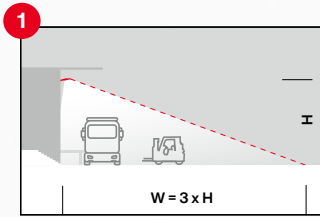

**PL43** – to illuminate areas using a narrow beam spread

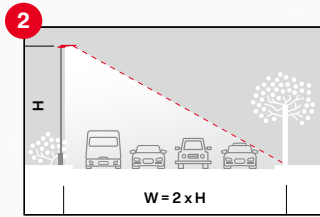
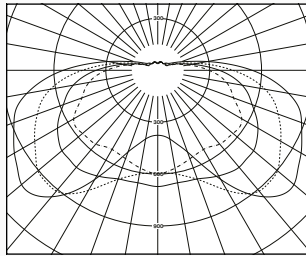

**PL52** – to illuminate wide streets and parking areas

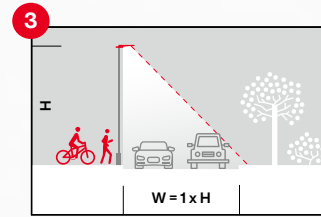
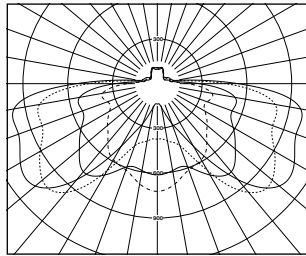

**PL61** – to illuminate streets with widely separated light points

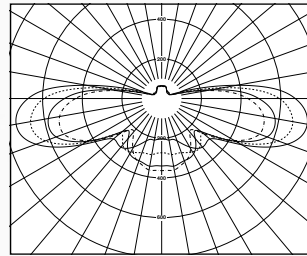

**PL64** – to illuminate areas using a narrow beam spread

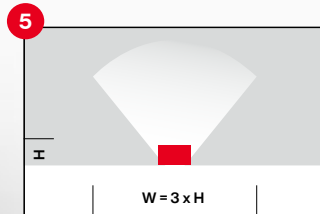
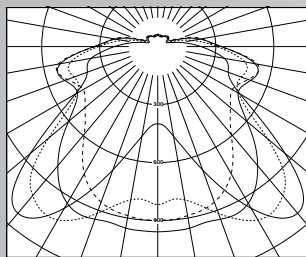

**PL33T** – to illuminate corners

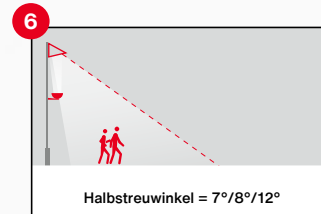
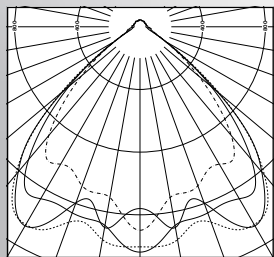

**RS07 | RS08 | RS12** – to use with Mirrortec applications and halls

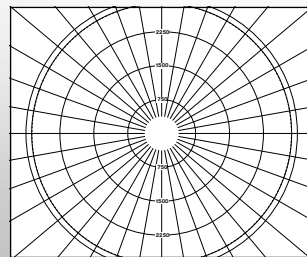

# Floodlight FL 21

## Models at a glance



**Floodlight FL 21 micro**

### Technical data

Luminous flux: 2,380 lm to 4,750 lm

Power: 23.1 W to 38.4 W

Luminous efficacy: up to 140 lm/W

Mounting heights: 3 m to 5 m

### Applications

Factory roads, area lighting

### Control

iQ Comfort, iQ Street Remote, DALI AC/DC, multilumen

### Light distribution

1 2 3 4 5 6

Valid for all Floodlight FL 21 models:

### Optical concept

precision lens technology with lenses made of non-yellowing PMMA

### Light colors and color rendering

2,200 K CRI 70 | 3,000 K CRI 70/80 | 4,000 K CRI 70/80 |  
5,700 K CRI 90

Light emission: 0 %



**Floodlight FL 21 mini**

**Technical data**

Luminous flux: 4,990 lm to 20,890 lm

Power: 45.5 W to 163.5 W

Luminous efficacy: up to 150 lm/W

Mounting heights: 5 m to 8 m

**Applications**

Parking lots, factory roads, area lighting, sports halls

**Control**

iQ Comfort, iQ Street Remote, DALI AC/DC, multilumen, Smart Interface

**Light distribution**

1 2 3 4 5 6

**Rated service life**

up to 100,000 hours

**Ambient temperature**

-40 °C to +40 °C indoors, -40 °C to +50 °C outdoors



**Floodlight FL 21 midi**

**Technical data**

Luminous flux: 21,270 lm to 39,970 lm

Power: 208.1 W to 286.6 W

Luminous efficacy: up to 142 lm/W

Mounting heights: 8 m to 12 m

**Applications**

Parking lots, logistics areas, sports halls, hangars

**Control**

iQ Comfort, iQ Street Remote, multilumen, Smart Interface

**Light distribution**

1 2 3 4 5 6

Available  
Q2/2024

Don't want to wait  
that long? Your  
alternative:



# Saving energy is teamwork.

How much work may we take off your hands?

## + Light audit

Our experts will take a look at your existing set up and define the individual requirements for the new plant with you on site. + Reduction of operating costs and CO<sub>2</sub> + Investment and payback

## + Planning

Tailored exactly to your needs, we develop a lighting concept or a customized solution – so that you can benefit from outstanding and sustainable lighting and control technology. + Lighting design + Lighting and electrical concept + Customizing solution

## + Project management

Everything from a single source – you have exactly one point of contact: your project manager. They handle the formalities and coordinate all steps – so that everything happens just in time, and everyone is well-integrated. + Project coordination and control

## + Financing

With our individual financing solutions, you save money from day one. The term is flexible and depends entirely on your needs. In addition, we prepare the efficiency proof of at least 50 % CO<sub>2</sub> savings for the funding application. + Government funding consultation + Financing

## + Service

You decide whether we handle the installation through our network of installation partners. If desired, we can also fully operate your system. + Installation and commissioning + Maintenance and servicing

Choose and combine these five service modules entirely according to your needs.

All tailored to your preferred level of service.

## Contact.

### Siteco GmbH

Georg-Simon-Ohm-Str. 50  
83301 Traunreut, Germany  
Tel. +49 8669 330  
info@siteco.com

siteco.com